

Simboli

Italia

Suscitare emozioni, creare uno stile puro e raffinato, curare i dettagli per esprimere armonia e rigore, unire tradizione e innovazione, offrire un prodotto che rispetti completamente la qualità del made in Italy: questo è Simboli.

Le collezioni che propone nascono dalla ricerca costante e dall'attenzione alle tendenze future, nell'ottica di accogliere le richieste e le esigenze più eterogenee attraverso articoli che soddisfino i propri desideri.

Arousing emotions, creating a pure and refined style, taking care of details to express harmony and rigor, combining tradition and innovation, offering a product that completely respects the quality of the Made in Italy: this is Simboli.

The collections it offers are born from constant research and attention to future trends, in order to accommodate the most heterogeneous requests and needs through items that satisfy own desires.

The Urban Life Collection Vol.1

Index

Dorian 6



Devon 16



Buddie 110



Gliss 120



Charles 26



Woody 38



Taylor 128



Margot 136



Alfred 52



Lewis 62



Yang 142



Adam 150



John 72



David 82



Shabby 160



Walter 168



Kendo 90



Moon 100



Dorian



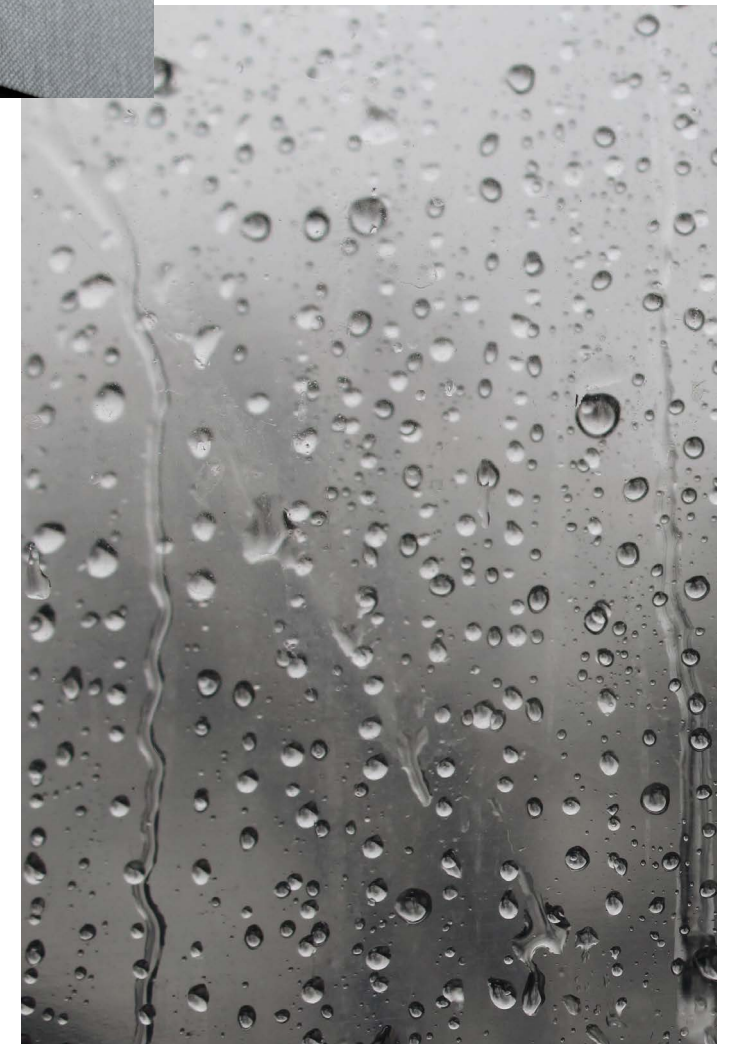
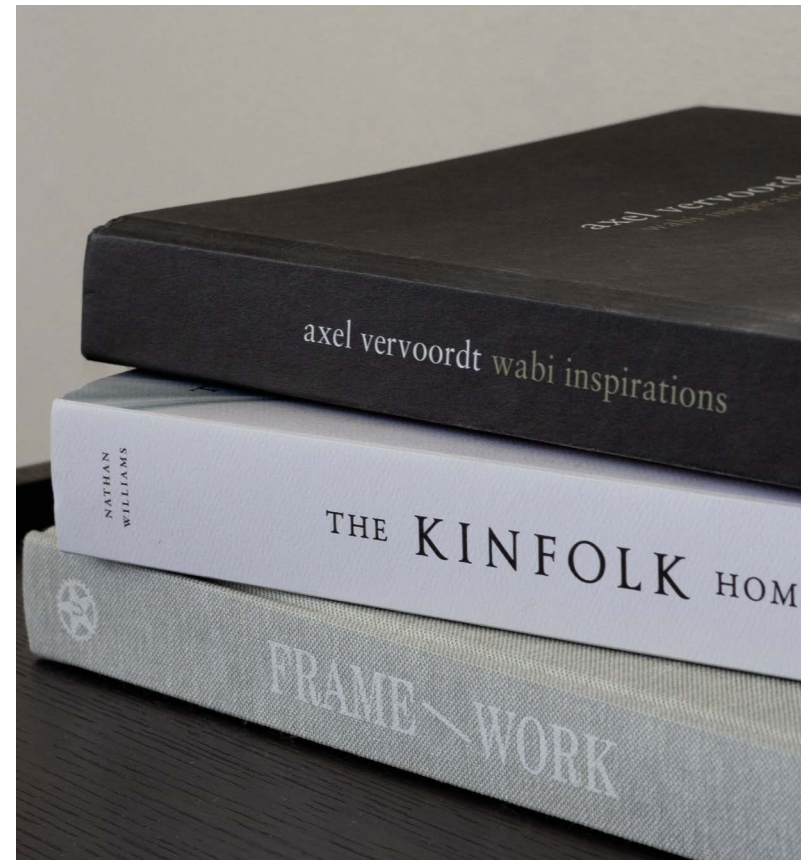





Dorian è un elemento di arredo versatile, in grado di adattarsi a qualsiasi stile di design e di trasformare istantaneamente un ambiente.”
Dorian is a piece of furniture versatile, able to adapt to any style of design and transform instantly an environment.”





Dorian

Materiali e rivestimenti (come foto) / Materials and coverings (As shown in photos)

Cat. Trend - **Art.** Imperial - **Col.** Taupe
 Cuscini (Pillows) - **Cat.** Trend - **Art.** Scarlett - **Col.** 34 & 32
 Piedi in plastica (Plastic feet)

Caratteristiche del modello / Model characteristics



Spalliere in piuma
 (Back in Oak Feather).



Sedute e spalliere sfoderabili
 (Seat and Back with removable covers).



Sedute in molleggio insacchettato
 (Seat with Pocket Springs).

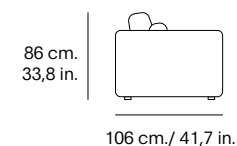

Larghezza bracciolo - Arm width 15 cm. / 5,9 in.
 Altezza seduta - Seat height 43 cm. / 16,9 in.
 Altezza bracciolo - Arm height 62 cm. / 24,4 in.
 Profondità seduta - Seat depth 70 cm. / 27,5 in.
 Altezza piedi - Feet height 4 cm. / 1,5 in.

Cod. 22128
 POLTRONA BRAC. SX
 CHAIR 1 ARM LHF

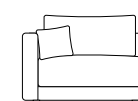

90 cm. / 35,4 in.
 106 cm. / 41,7 in.

Cod. 22120
 POLTRONA BRAC. DX
 CHAIR 1 ARM RHF



90 cm. / 35,4 in.
 106 cm. / 41,7 in.

Cod. 22105
 POLTRONA CENTRALE 90
 ARMLESS CHAIR 90

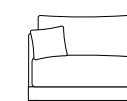

91 cm. / 35,8 in.

Cod. 22000
 POUFF
 FOOTSTOOL



43/16,9
 cm./in.
 90 cm. / 35,4 in.

Cod. 22500
 ANGOLO
 CORNER

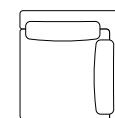

90 cm. / 35,4 in.
 106 cm. / 41,7 in.



Devon





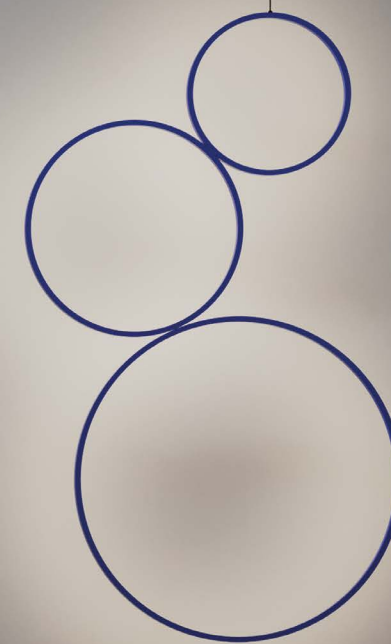

Materiali e design: Il Devon è disponibile in vari materiali, come pelle, microfibra o tessuto, per adattarsi al tuo stile e al tuo arredamento. Puoi scegliere tra diverse configurazioni secondo il tuo mood.

Materials and design: The Devon is available in various covering materials like leather, microfiber and fabric in order to adapt itself to your style and your ambiance. You can choose from different configurations matching your mood.

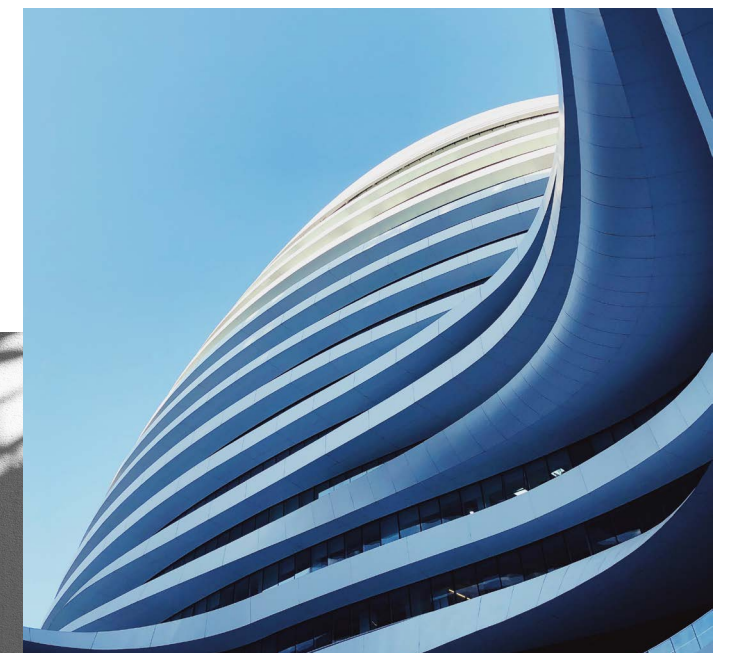

Devon

Materiali e rivestimenti (come foto)

Materials and coverings (As shown in photos)

Cat. Trend - Art. Scarlett - Col. 32

Cuscini/Pouf (Loose pillows and Footstool) **Cat. Trend - Art. Asset - Col. Cement**

Piedi in plastica (plastic feet)

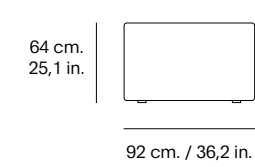

Larghezza bracciolo - *Arm width* 25 cm. / 9,8 in.
 Altezza seduta - *Seat height* 38 cm. / 14,9 in.
 Altezza bracciolo - *Arm height* 64 cm. / 25,1 in.
 Profondità seduta - *Seat depth* 68 cm. / 26,7 in.
 Altezza piedi - *Foot height* 4 cm. / 1,5 in.

Cod. 22128
POLTRONA BRAC. SX
CHAIR 1 ARM LHF

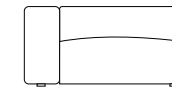

90 cm. / 35,4 in.
115 cm. / 45,2 in.

Cod. 22120
POLTRONA BRAC. DX 90
CHAIR 1 ARM RHF 90

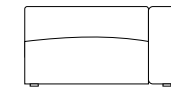

90 cm. / 35,4 in.
115 cm. / 45,2 in.

Cod. 22105
POLTRONA CENTRALE 90
ARMLESS CHAIR 90

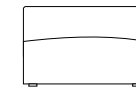

90 cm. / 35,4 in.

Cod. 22108
POLTRONA BRAC. SX 70
CHAIR 1 ARM LHF 70

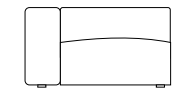

70 cm. / 27,5 in.
95 cm. / 37,4 in.

Cod. 22100
POLTRONA BRAC. DX 70
CHAIR 1 ARM RHF 70

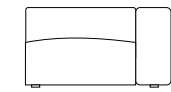

70 cm. / 27,5 in.
95 cm. / 37,4 in.

Cod. 22085
POLTRONA CENTRALE 70
ARMLESS CHAIR 70

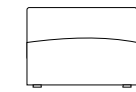

70 cm. / 27,5 in.

Cod. 22000
POUFF
FOOTSTOOL

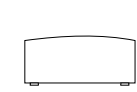

38 cm.
14,9 in.
70 cm. / 27,5 in.

Cod. 22708
CHAISE LONGUE BRAC. SX
CHAISE LONGUE 1 ARM LHF

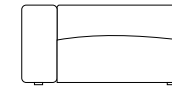

90 cm. / 35,4 in.
115 cm. / 45,2 in.

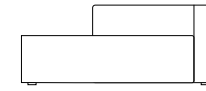

152 cm. / 59,8 in.

Cod. 22700
CHAISE LONGUE BRAC. DX
CHAISE LONGUE 1 ARM RHF

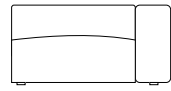

90 cm. / 35,4 in.
115 cm. / 45,2 in.

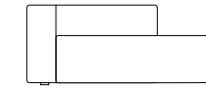

152 cm. / 59,8 in.

Cod. 22500
ANGOLO
CORNER

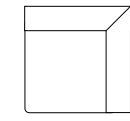

92 cm.
36,2 in.
67 cm. / 26,3 in.
92 cm. / 36,2 in.



Charles







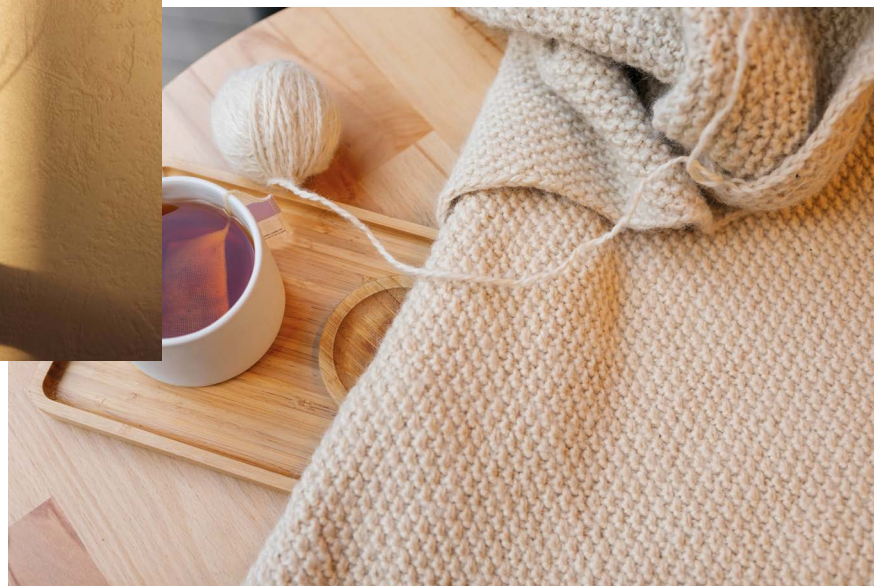
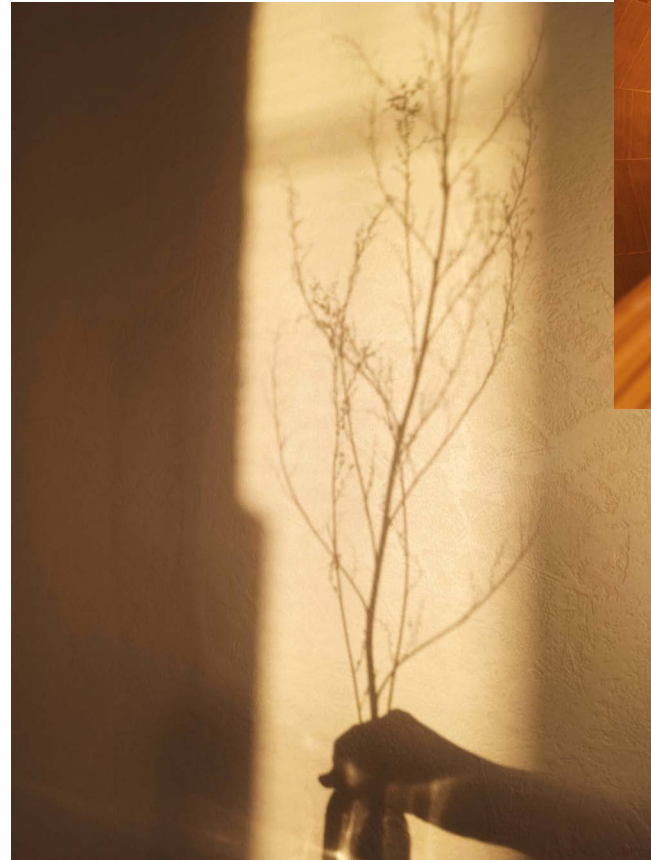
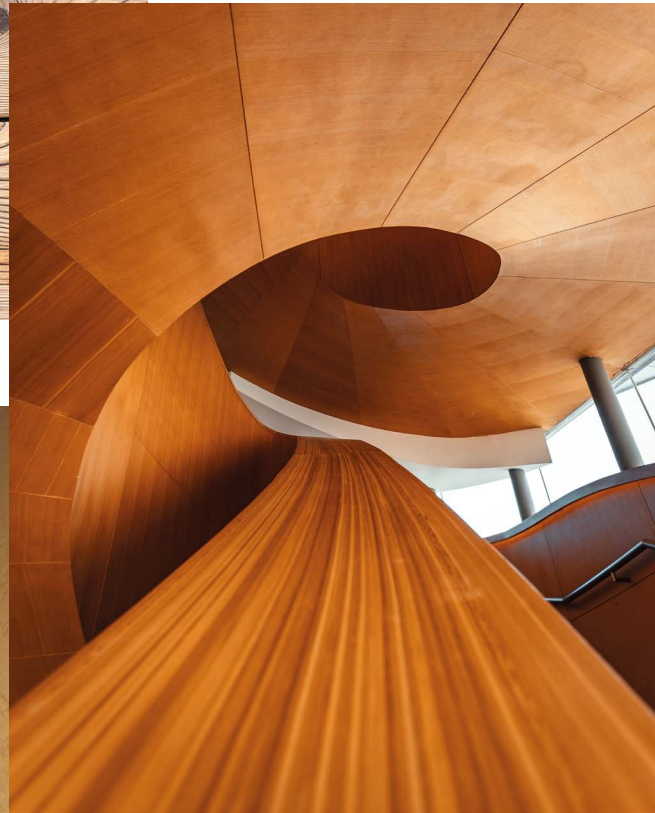
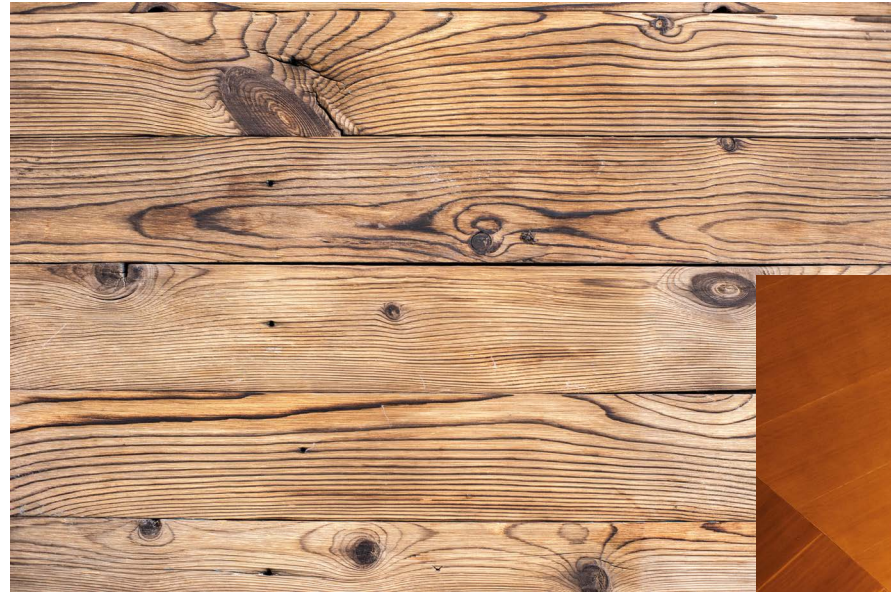





Charles

Materiali e rivestimenti (come foto) / Materials and coverings (As shown in photos)

Cat. Air - Art. Galaxy - Col. 7302

Cat. Trend - Art. Relax - Col. 100

Pouf (Footstool) Cat. Essential - Art. Sunset - Col. 4007

Piedi in plastica (Plastic feet)

Caratteristiche del modello / Model characteristics



Seduta in piuma
(Seat in Oak Feather)



Bracciolo disponibile nella versione impunturata o pizzicata
(Arms available with pinched piping or regular stitching)

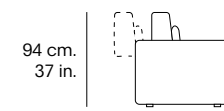

94 cm.
37 in.

110/140 cm. / 43,3/55,1 in.

Larghezza bracciolo - Arm width 22 cm. / 8,6 in.
Altezza seduta - Seat height 45 cm. / 17,7 in.
Altezza bracciolo - Arm height 60 cm. / 23,6 in.
Profondità seduta - Seat depth 67 cm. / 26,3 in.
Altezza piedi - Feet height 4 cm. / 1,5 in.

Cod. 22128
POLTRONA BRAC. SX
CHAIR 1 ARM LHF

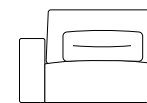

100 cm. / 39,3 in.

122 cm. / 48 in.

Cod. 22120
POLTRONA BRAC. DX
CHAIR 1 ARM RHF

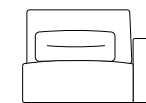

100 cm. / 39,3 in.

122 cm. / 48 in.

Cod. 22105
POLTRONA CENTRALE
ARMLESS CHAIR

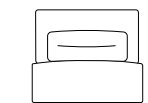

100 cm. / 39,3 in.

Cod. 22108
POLTRONA BRAC. SX
CHAIR 1 ARM LHF

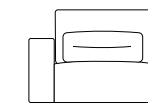

80 cm. / 31,4 in.

102 cm. / 40,1 in.

Cod. 22100
POLTRONA BRAC. DX
CHAIR 1 ARM RHF

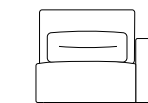

80 cm. / 31,4 in.

102 cm. / 40,1 in.

Cod. 22085
POLTRONA CENTRALE
ARMLESS CHAIR

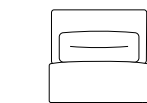

80 cm. / 31,4 in.

Cod. 22708
POLTRONA TERM. MAXI SX
TERMINAL CHAIR MAXI LHF

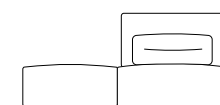

80 / 31,4 100 / 39,3

180 cm. / 70,8 in.

Cod. 22700
POLTRONA TERM. MAXI DX
TERMINAL CHAIR MAXI RHF

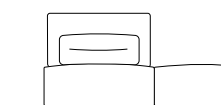

100 / 39,3 80 / 31,4

180 cm. / 70,8 in.

Cod. 22608
POLTRONA TERMINALE SX
TERMINAL CHAIR LHF

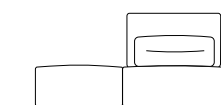

80 / 31,4 80 / 31,4

160 cm. / 62,9 in.

Cod. 22600
POLTRONA TERMINALE DX
TERMINAL CHAIR RHF

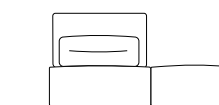

80 / 31,4 80 / 31,4

160 cm. / 62,9 in.

Cod. 22500
ANGOLO
CORNER

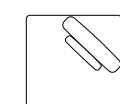

110 cm.
43,3 in.

Cod. 22000
POUFF
FOOTSTOOL

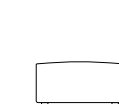

45 cm.
17,7 in.

Woody



Woody con il suo design ben bilanciato e con le sue proporzioni armoniose tra seduta, braccioli e schienale contribuisce ad un comfort equilibrato e ad un' estetica piacevole.

Woody with its well designed and balanced harmonious proportions between seat, armrests and backrest contributes to a good comfort and aesthetically pleasing view.









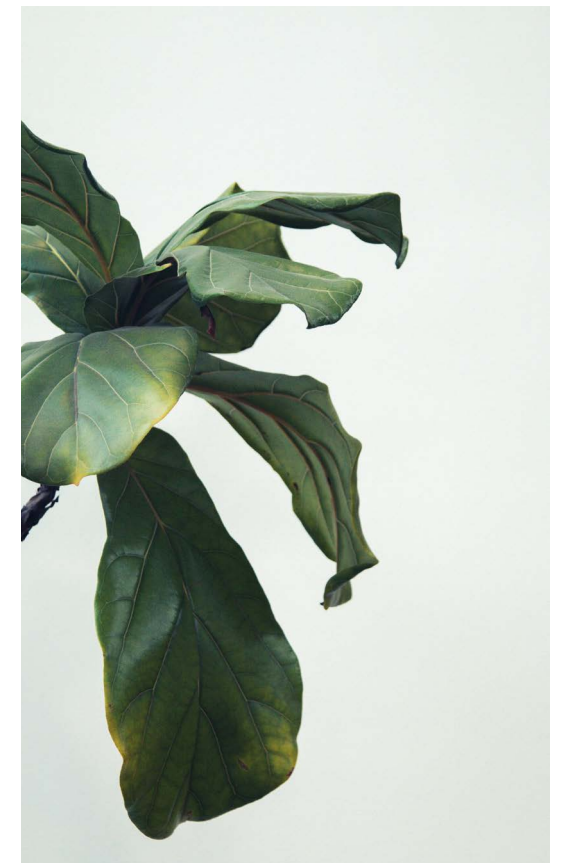

Woody

Materiali e rivestimenti (come foto) / Materials and coverings (As shown in photos)

Cat. Essential - Art. Sunset - Col. 4009
 Cuscini (Pillows) **Cat. Trend - Art. Casinò - Col. Ash, Art. Casinò - Col. Antracite**
 Cuscini (Pillows) **Cat. Life - Art. Celtic - Col. Forest**
 Piedi in acciaio (Steel feet) col. Nero opaco

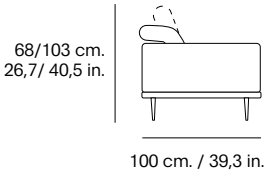

Larghezza bracciolo - *Arm width* 24 cm. / 9,4 in.
 Altezza seduta - *Seat height* 43 cm. / 16,9 in.
 Altezza bracciolo - *Arm height* 57 cm. / 22,4 in.
 Profondità seduta - *Seat depth* 59 cm. / 23,2 in.
 Altezza piedi - *Feet height* 17 cm. / 6,6 in.

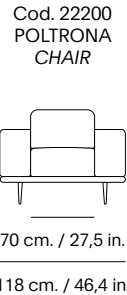
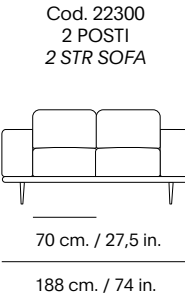
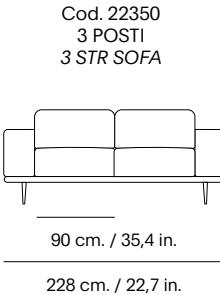
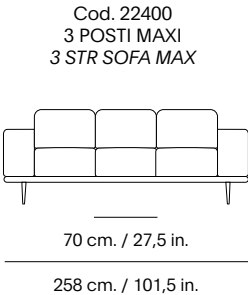

Alfred







Alfred e la sua profondità di seduta consente di assumere una posizione rilassata e di comfort.

Alfred and its depth of seat area allows you to stretch your legs and find a relaxed position, providing enough space to sit comfortably.

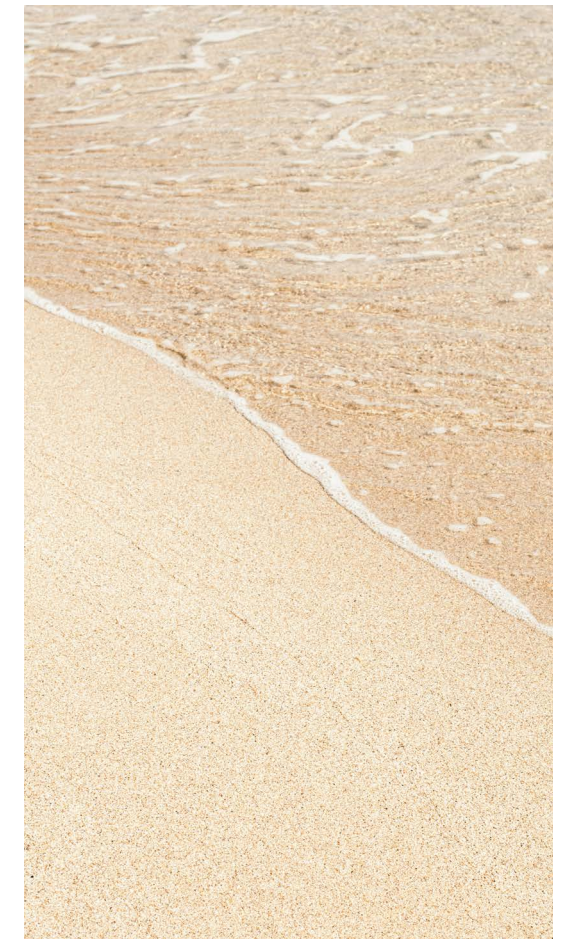
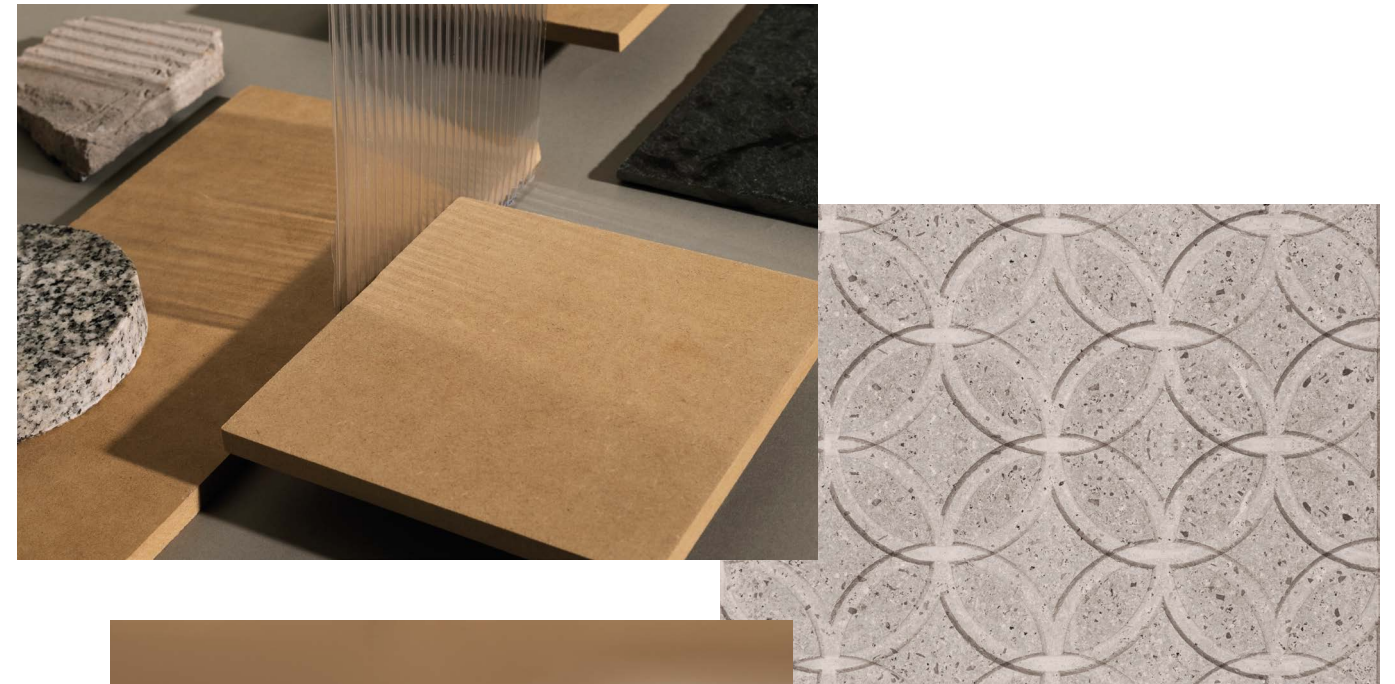

Alfred



Materiali e rivestimenti (come foto) / Materials and coverings (As shown in photos)

Cat. Trend - Art. Relax - Col. 25;
 Cuscini (Pillows) **Cat. Trend - Art. Casinò - Col. Chocolate, Cat. Trend - Art. Casinò - Col. Terra**
 Piedi in acciaio (Steel feet) col. Nero Opaco

Caratteristiche del modello / Model characteristics



Sedute e spalliere in piuma
 (Seat and Back in oak feather)



Sedute e spalliere sfoderabili
 (Seat and Back with removable covers).



Cuscini volanti inclusi
 (Loose cushions included)

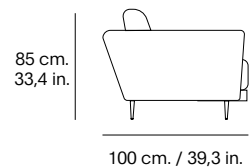

Larghezza bracciolo - Arm width 19 cm. / 7,4 in.
 Altezza seduta - Seat height 42 cm. / 16,5 in.
 Altezza bracciolo - Arm height 69 cm. / 27,1 in.
 Profondità seduta - Seat depth 56 cm. / 22 in.
 Altezza piedi - Feet height 17 cm. / 6,6 in.

<p>Cod. 22400 3 POSTI MAXI 3 STR SOFA MAX</p> <p>100 cm. / 39,3 in. 238 cm. / 93,7 in.</p>	<p>Cod. 22423 3 POSTI MAXI BRAC.SX 3 STR SOFA MAX LHF</p> <p>100 cm. / 39,3 in. 219 cm. / 86,2 in.</p>	<p>Cod. 22415 3 POSTI MAXI BRAC.DX 3 STR SOFA MAX RHF</p> <p>100 cm. / 39,3 in. 219 cm. / 86,2 in.</p>	<p>Cod. 22350 3 POSTI 3 STR SOFA</p> <p>85 cm. / 33,4 in. 208 cm. / 81,8 in.</p>	<p>Cod. 22373 3 POSTI BRAC. SX 3 STR SOFA LHF</p> <p>85 cm. / 33,4 in. 189 cm. / 74,4 in.</p>	<p>Cod. 22365 3 POSTI BRAC. DX 3 STR SOFA RHF</p> <p>85 cm. / 33,4 in. 189 cm. / 74,4 in.</p>
<p>Cod. 22300 2 POSTI 2 STR SOFA</p> <p>75 cm. / 29,5 in. 188 cm. / 74 in.</p>	<p>Cod. 22323 2 POSTI BRAC. SX 2 STR SOFA LHF</p> <p>75 cm. / 29,5 in. 169 cm. / 66,5 in.</p>	<p>Cod. 22315 2 POSTI BRAC.DX 2 STR SOFA RHF</p> <p>75 cm. / 29,5 in. 169 cm. / 66,5 in.</p>	<p>Cod. 22200 POLTRONA CHAIR</p> <p>75 cm. / 29,5 in. 113 cm. / 44,4</p>		
<p>Cod. 22788 CHAISE LONGUE MAX BRAC. SX CHAISE LONGUE MAX 1 ARM LHF</p> <p>130 cm. / 51,1 in. 149 cm. / 58,6 in.</p>	<p>Cod. 22780 CHAISE LONGUE MAX BRAC. DX CHAISE LONGUE MAX 1 ARM RHF</p> <p>162 cm. / 63,7 in. 149 cm. / 58,6 in.</p>				
<p>Cod. 22708 CHAISE LONGUE BRAC. SX CHAISE LONGUE 1 ARM LHF</p> <p>100 cm. / 39,3 in. 119 cm. / 46,8 in.</p>	<p>Cod. 22700 CHAISE LONGUE BRAC. DX CHAISE LONGUE 1 ARM RHF</p> <p>162 cm. / 63,7 in. 119 cm. / 46,8 in.</p>				
<p>Cod. 22608 CHAISE LONGUE MINI BRAC. SX CHAISE LONGUE MINI 1 ARM LHF</p> <p>85 cm. / 33,4 in. 104 cm. / 40,9 in.</p>	<p>Cod. 22600 CHAISE LONGUE MINI BRAC. DX CHAISE LONGUE MINI 1 ARM RHF</p> <p>162 cm. / 63,7 in. 104 cm. / 40,9 in.</p>				

Lewis







100 CONTEMPORARY HOUSES
SAARINEN

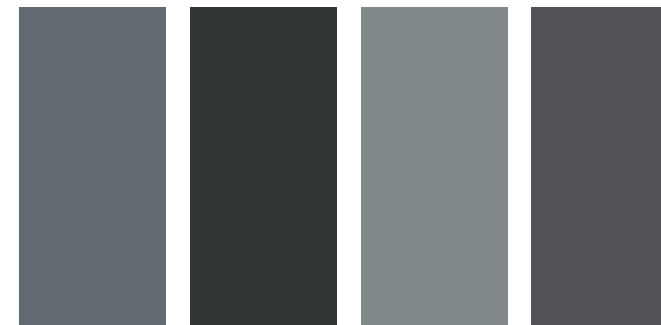
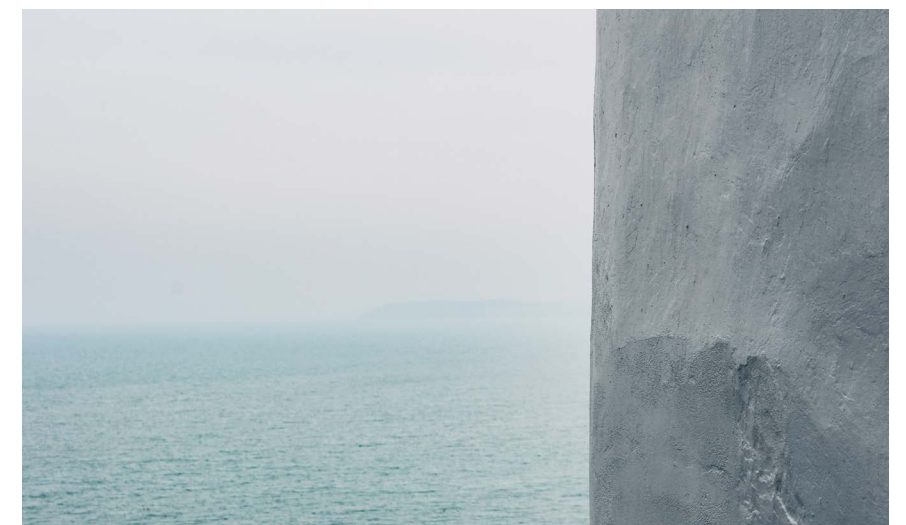
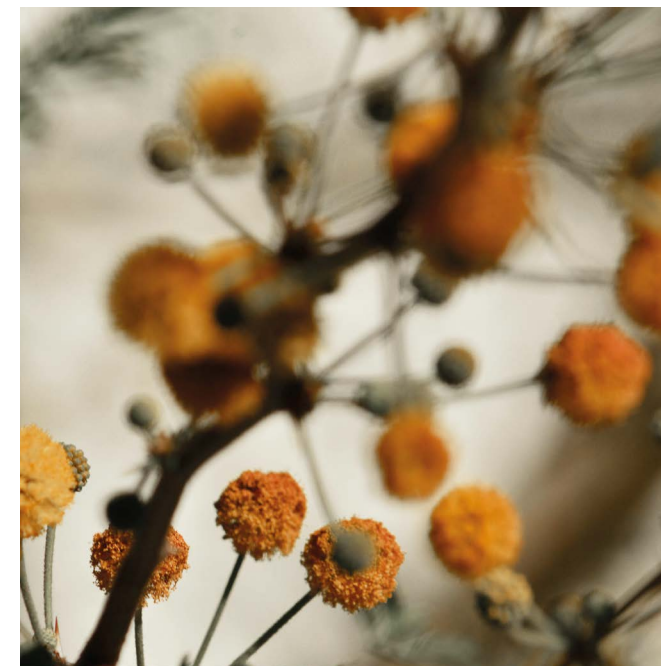

Lewis

Materiali e rivestimenti (come foto) / Materials and coverings (As shown in photos)

Cat. Life - Art. Norris - Col. 25
 Cuscini (Pillows) **Cat. Trend - Art. Casinò - Col. Brick, Cat. Trend - Art. Casinò - Col. Gold**
 Fibbia rullo (Roller belt) **Cat. Air - Art. Galaxy - Col. 7310**
 Piedi in acciaio (Steel feet) col. Cromato lucido

Caratteristiche del modello / Model characteristics

-  Spalliere in piuma (Back in Oak Feather).
-  Sedute e spalliere sfoderabili (Seat and Back with removable covers).

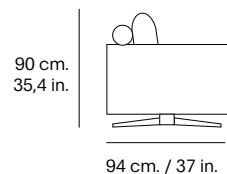

Larghezza bracciolo - Arm width 17 cm. / 6,6 in.
 Altezza seduta - Seat height 44 cm. / 17,3 in.
 Altezza bracciolo - Arm height 59 cm. / 23,2 in.
 Profondità seduta - Seat depth 59 cm. / 23,2 in.
 Altezza piedi - Feet height 13,5 cm. / 5,3 in.

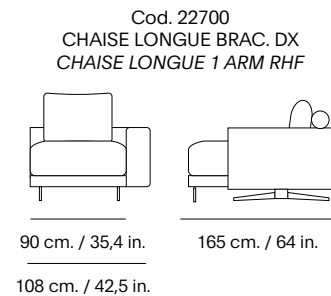
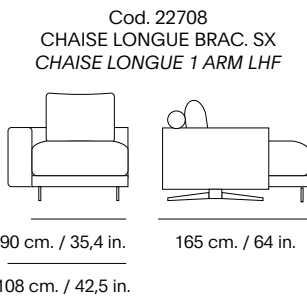
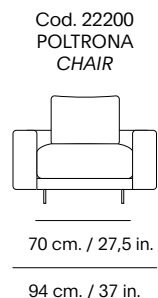
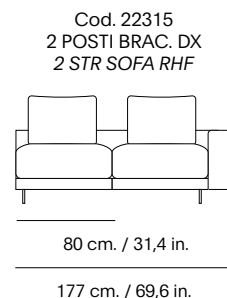
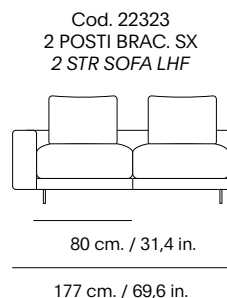
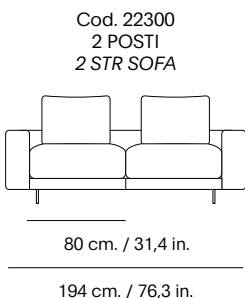
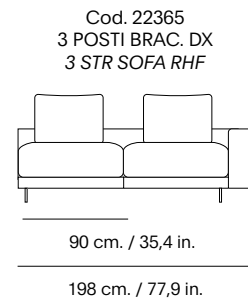
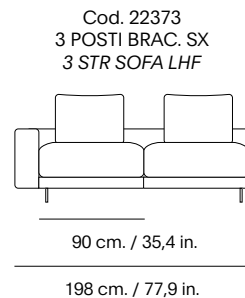
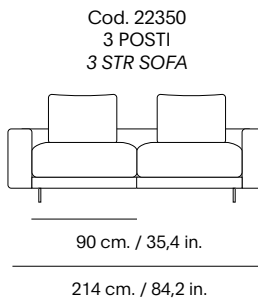

John







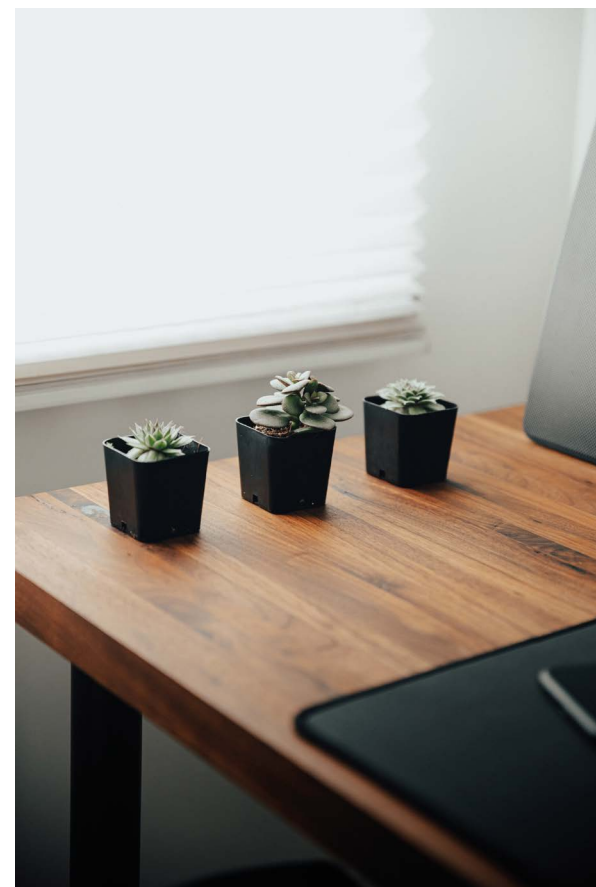
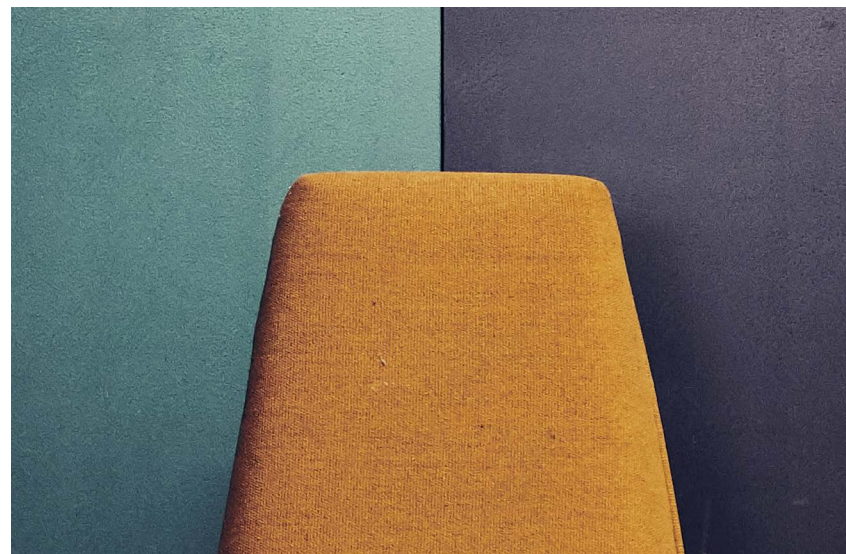



John

Materiali e rivestimenti (come foto)
Materials and coverings (As shown in photos)

Cat. Basic Art. Experience - **Col.** 3015
 Cuscino (Pillow) **Cat.** Trend - **Art.** Casinò - **Col.** Terra
 Piedi in acciaio (Steel feet) col. Cromato lucido

Caratteristiche del modello / Model characteristics
 Poggiatesta regolabile (Tilted headrest available)

Optional Batteria e presa USB sono ordinabili su richiesta
 USB Plug-in Battery Pack Sold Separately (Upon request)

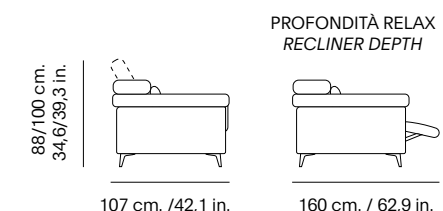

PROFONDITÀ RELAX
RECLINER DEPTH

Larghezza bracciolo - *Arm width* 30 cm. / 11,8 in.
 Altezza seduta - *Seat height* 45 cm. / 17,7 in.
 Altezza bracciolo - *Arm height* 60 cm. / 23,6 in.
 Profondità seduta - *Seat depth* 55 cm. / 21,6 in.
 Altezza piedi - *Feet height* 13 cm. / 5,1 in.

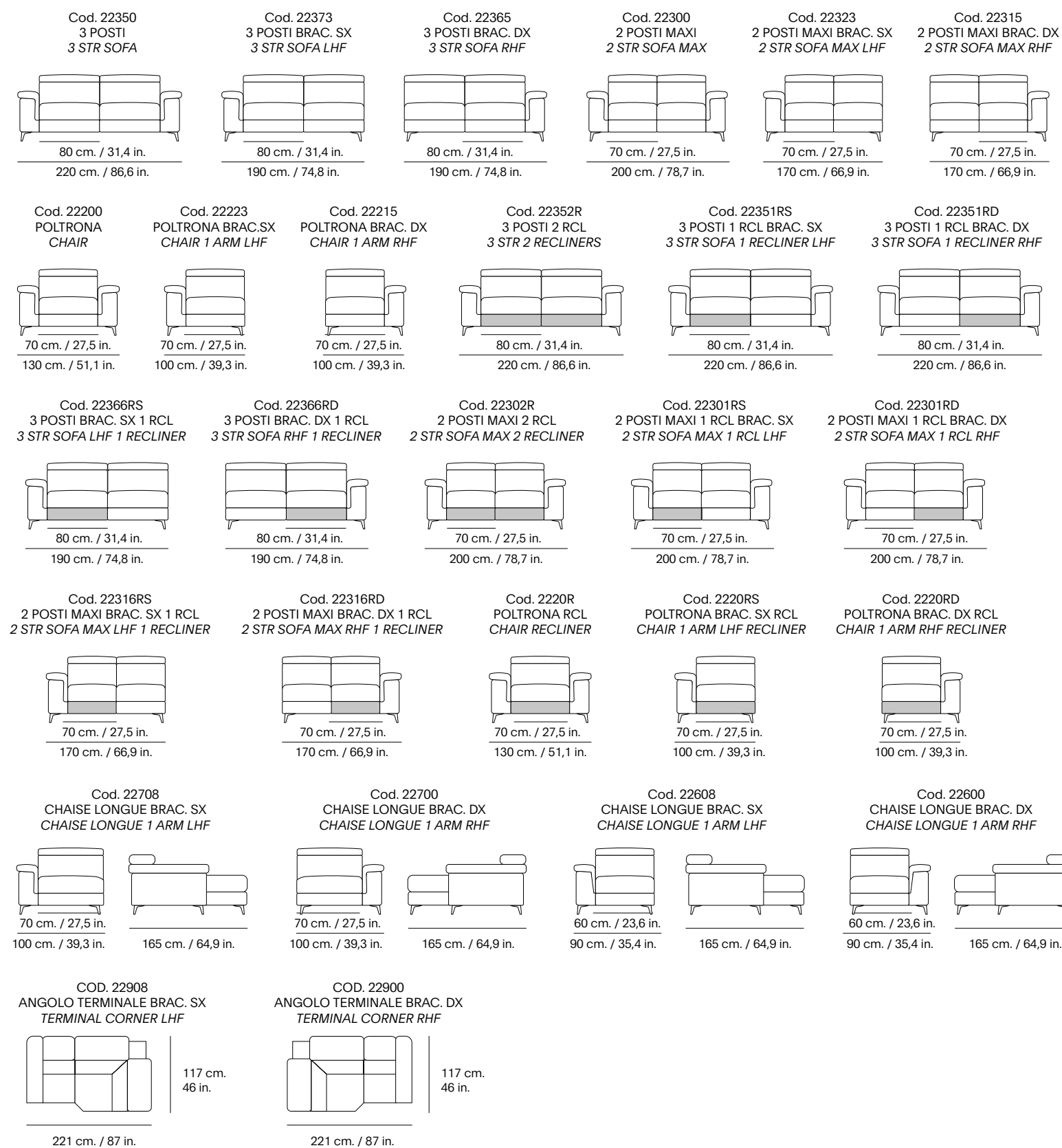

David







David

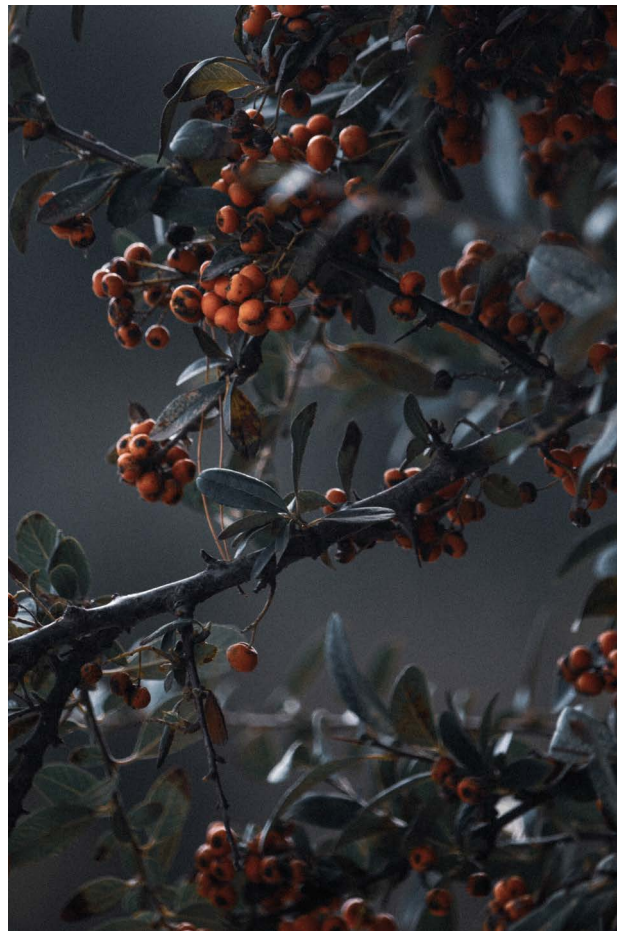
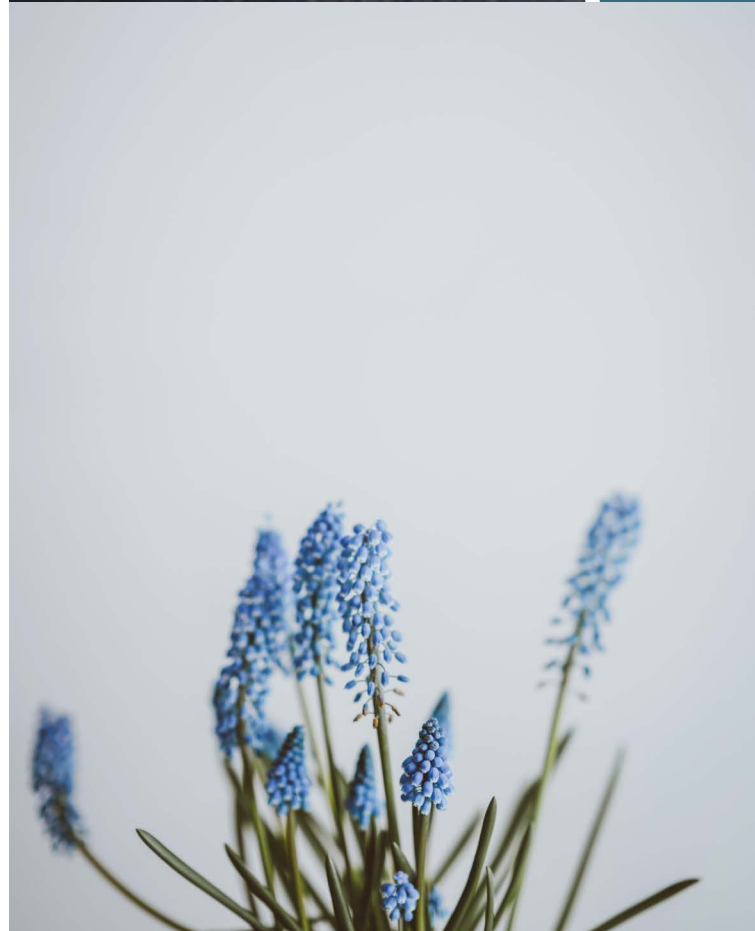
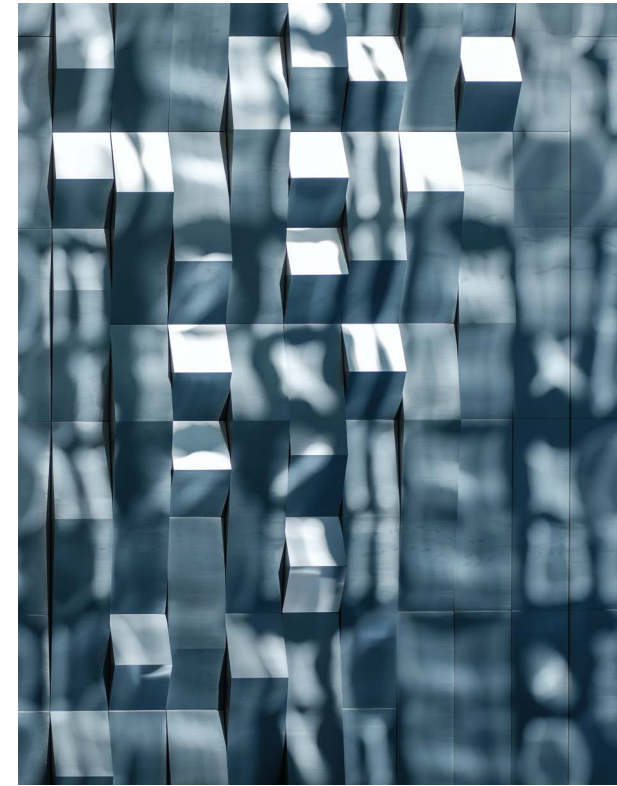

Materiali e rivestimenti (come foto) / Materials and coverings (As shown in photos)
Cat. Trend - Art. Award - Col. 53
 Piedi in legno (Wooden feet) col. Wengè
 Materasso H 16 cm. / 5,9 in. (Mattress Height 16 cm. / 5,9 in.)

Caratteristiche del modello / Model characteristics



Completamento sfoderabile
 (Completely removable covers)



In Pelle, solo cuscini seduta sfoderabili
 (In leather, seat cushions removable ONLY)

C.L. reversibile
 (C.L. reversible)

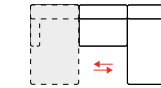

Disponibile con materassi
 (Available with mattresses)



140x190 cm.
 55,1x74,8 in.

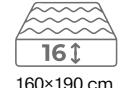

160x190 cm.
 62,9x74,8 in.

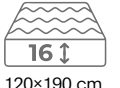

120x190 cm.
 47,2x74,8 in.

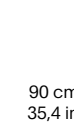

90 cm.
 35,4 in.

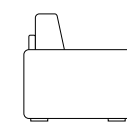

95 cm. / 37,4 in.

PROFONDITÀ VERSIONE LETTO
 BED VERSION DEPTH

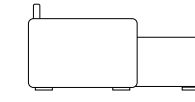

207 cm. / 81,4 in.

Larghezza bracciolo - Arm width 18 cm. / 7 in.
 Altezza seduta - Seat height 48 cm. / 18,8 in.
 Altezza bracciolo - Arm height 60 cm. / 23,6 in.
 Profondità seduta - Seat depth 54 cm. / 21,2 in.
 Altezza piedi - Feet height 4,5 cm. / 1,7 in.

Cod. 22408
 3 POSTI MAXI LETTO
 3 STR SOFA MAX W/BED

91 cm. / 31,8 in.
 220 cm. / 86,6 in.
 Materasso 160 cm. / Mattress 62,9 in.

Cod. 22426
 3 POSTI MAXI LETTO BRAC. SX
 3 STR SOFA MAX LHF W/BED

91 cm. / 35,8 in.
 200 cm. / 78,7 in.
 Materasso 160 cm. / Mattress 62,9 in.

Cod. 22418
 3 POSTI MAXI LETTO BRAC. DX
 3 STR SOFA MAX RHF W/BED

91 cm. / 35,8 in.
 200 cm. / 78,7 in.
 Materasso 160 cm. / Mattress 62,9 in.

Cod. 22358
 3 POSTI LETTO
 2 STR SOFA W/BED

81 cm. / 78,7 in.
 200 cm. / 78,7 in.
 Materasso 140 cm. / Mattress 55,1 in.

Cod. 22376
 3 POSTI LETTO BRAC. SX
 3 STR SOFA LHF W/BED

81 cm. / 78,7 in.
 180 cm. / 70,8 in.
 Materasso 140 cm. / Mattress 55,1 in.

Cod. 22368
 3 POSTI LETTO BRAC. DX
 3 STR SOFA RHF W/BED

81 cm. / 78,7 in.
 180 cm. / 70,8 in.
 Materasso 140 cm. / Mattress 55,1 in.

Cod. 22308
 2 POSTI MAXI LETTO
 2 STR SOFA MAX W/BED

71 cm. / 27,9 in.
 180 cm. / 70,8 in.
 Materasso 120 cm. / Mattress 47,2 in.

Cod. 22326
 2 POSTI MAXI LETTO BRAC. SX
 2 STR SOFA MAX LHF W/BED

71 cm. / 27,9 in.
 160 cm. / 62,9 in.
 Materasso 120 cm. / Mattress 47,2 in.

Cod. 22318
 2 POSTI MAXI LETTO BRAC. DX
 2 STR SOFA MAX RHF W/BED

71 cm. / 27,9 in.
 160 cm. / 62,9 in.
 Materasso 120 cm. / Mattress 47,2 in.

Cod. 22758
 CHAISE LONGUE CONTENITORE BRAC. SX
 CHAISE LONGUE 1 ARM LHF W/CONTAINER

81 cm. / 78,7 in. 160 cm. / 62,9 in.
 100 cm. / 39,3 in.

Cod. 22750
 CHAISE LONGUE CONTENITORE BRAC. DX
 CHAISE LONGUE 1 ARM RHF W/CONTAINER

81 cm. / 78,7 in. 160 cm. / 62,9 in.
 100 cm. / 39,3 in.

Kendo



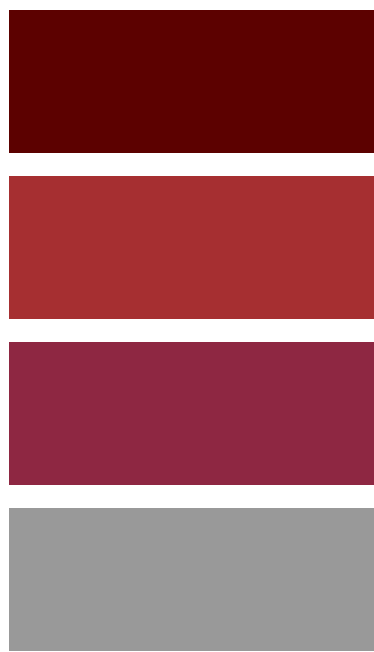







Kendo

Materiali e rivestimenti (come foto) / Materials and coverings (As shown in photos)

Cat. Essential - Art. Vintage - Col. 8001;
 Cuscini (Pillows) Cat. Trend - Art. Tixer - Col. 35
 Piedi in acciaio (Steel feet) col. Nero opaco

Caratteristiche del modello / Model characteristics



Spalliera con piuma d'oca
 (Back cushions with oak feather)



Cuscini e spalliere sfoderabili
 (Seat and back with removable covers)

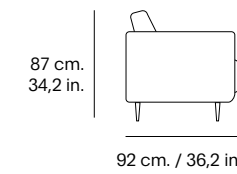

Larghezza bracciolo - Arm width 9 cm. / 3.5 in.
 Altezza seduta - Seat height 45 cm. / 17.7 in.
 Altezza bracciolo - Arm height 69 cm. / 27.1 in.
 Profondità seduta - Seat depth 56 cm. / 22 in.
 Altezza piedi - Feet height 17 cm. / 6.6 in.

Cod. 22350
 3 POSTI
 3 STR SOFA

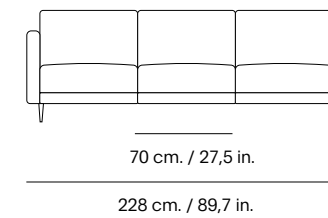

Cod. 22300
 2 POSTI
 2 STR SOFA

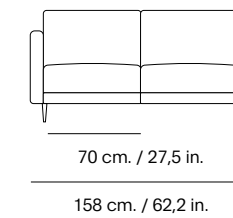

Cod. 22200
 POLTRONA
 CHAIR

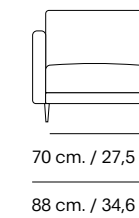

Moon







"Moon è il tuo rifugio di comfort personale, dove puoi creare il tuo angolo di relax e coccolarti nel tuo tempo libero"

"Moon is your personal comfort haven, where you can create your own corner of relaxation and pamper yourself on your free time"

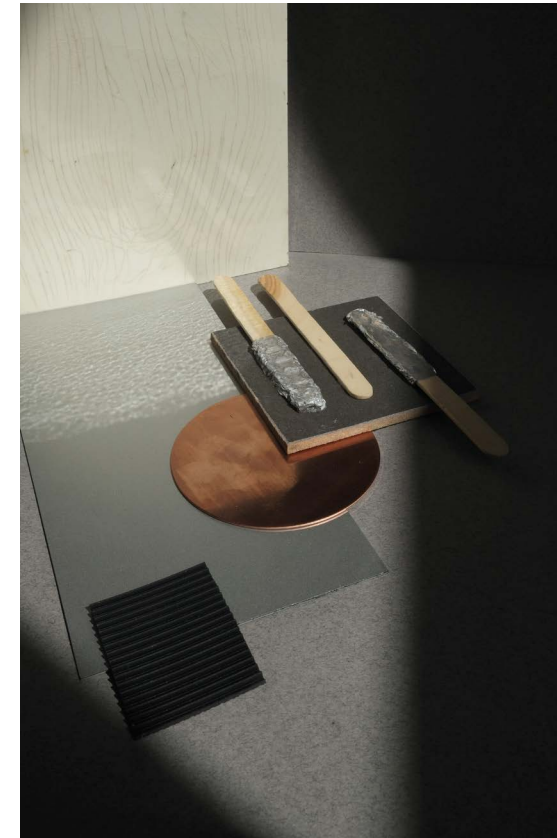

Moon

Materiali e rivestimenti (come foto) / Materials and coverings (As shown in photos)

Cat. Life - Art. Celtic - Col. Light Grey
 Cuscini (Pillows) Cat. Life - Art. Amy - Col. Green
 Piedi in plastica (Plastic feet)
 Materasso H.16 cm. (Mattress Height 16 cm. / 6,2 inches)

Disponibile con materassi
 (Available with mattresses)

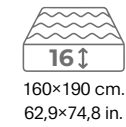
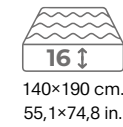

Caratteristiche del modello / Model characteristics

Completamento sfoderabile
 (Completely removable covers)

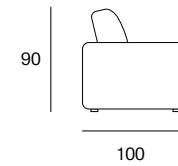

Larghezza bracciolo - Arm width 20
 Altezza seduta - Seat height 46
 Altezza bracciolo - Arm height 66
 Profondità seduta - Seat depth 58
 Altezza piedi - Feet height 4 cm. / 1,5 in.



Cod. 22408
 3 POSTI LETTO MAXI
 3 STR SOFA MAX W/BED

90 cm. / 35,4 in.
 220 cm. / 86,6 in.
 Materasso 160 cm. / Mattress 62,9 in.

Cod. 22426
 3 POSTI LETTO MAXI BRAC. SX
 3 STR SOFA MAX LHF W/BED

90 cm. / 35,4 in.
 200 cm. / 78,7 in.
 Materasso 160 cm. / Mattress 62,9 in.

Cod. 22418
 3 POSTI LETTO MAXI BRAC. DX
 3 STR SOFA MAX RHF W/BED

90 cm. / 35,4 in.
 200 cm. / 78,7 in.
 Materasso 160 cm. / Mattress 62,9 in.

Cod. 22358
 3 POSTI LETTO
 3 STR SOFA W/BED

80 cm. / 31,4 in.
 200 cm. / 78,7 in.
 Materasso 140 cm. / Mattress 55,1 in.

Cod. 22376
 3 POSTI LETTO BRAC. SX
 3 STR SOFA LHF W/BED

80 cm. / 31,4 in.
 180 cm. / 70,8 in.
 Materasso 140 cm. / Mattress 55,1 in.

Cod. 22368
 3 POSTI LETTO BRAC. DX
 3 STR SOFA RHF W/BED

80 cm. / 31,4 in.
 180 cm. / 70,8 in.
 Materasso 140 cm. / Mattress 55,1 in.

Cod. 22708
 CHAISE LONGUE 45 BRAC. SX
 CHAISE LONGUE 1 ARM LHF

175 cm. / 68,8 in.
 145 cm. / 57 in.

Cod. 22700
 CHAISE LONGUE 45 BRAC. DX
 CHAISE LONGUE 1 ARM RHF

175 cm. / 68,8 in.
 145 cm. / 57 in.

Buddie







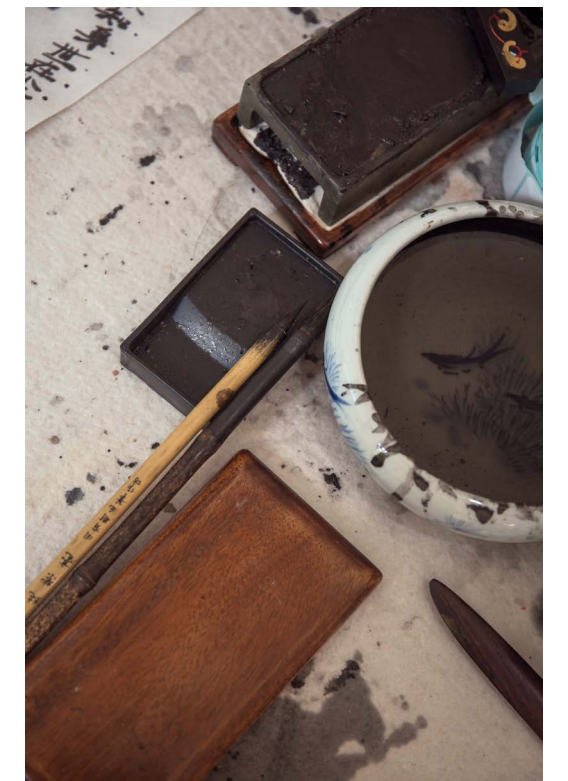
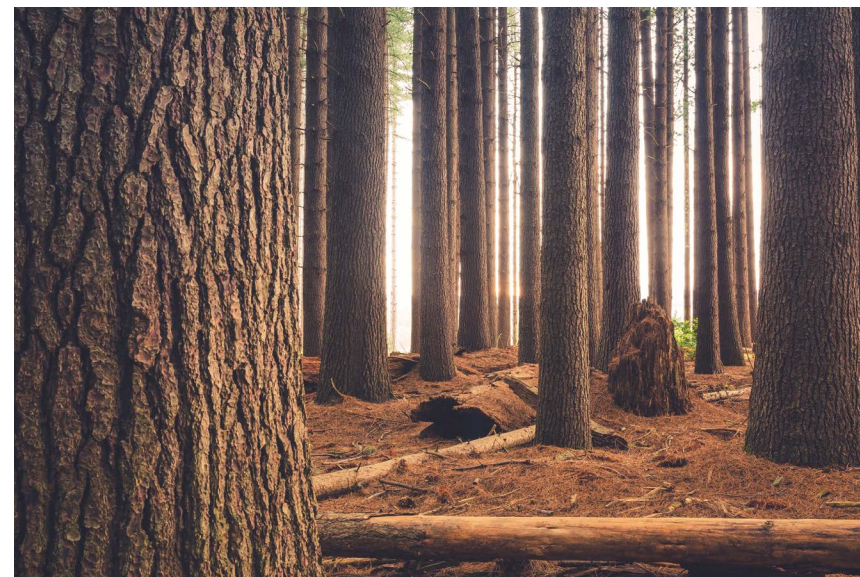
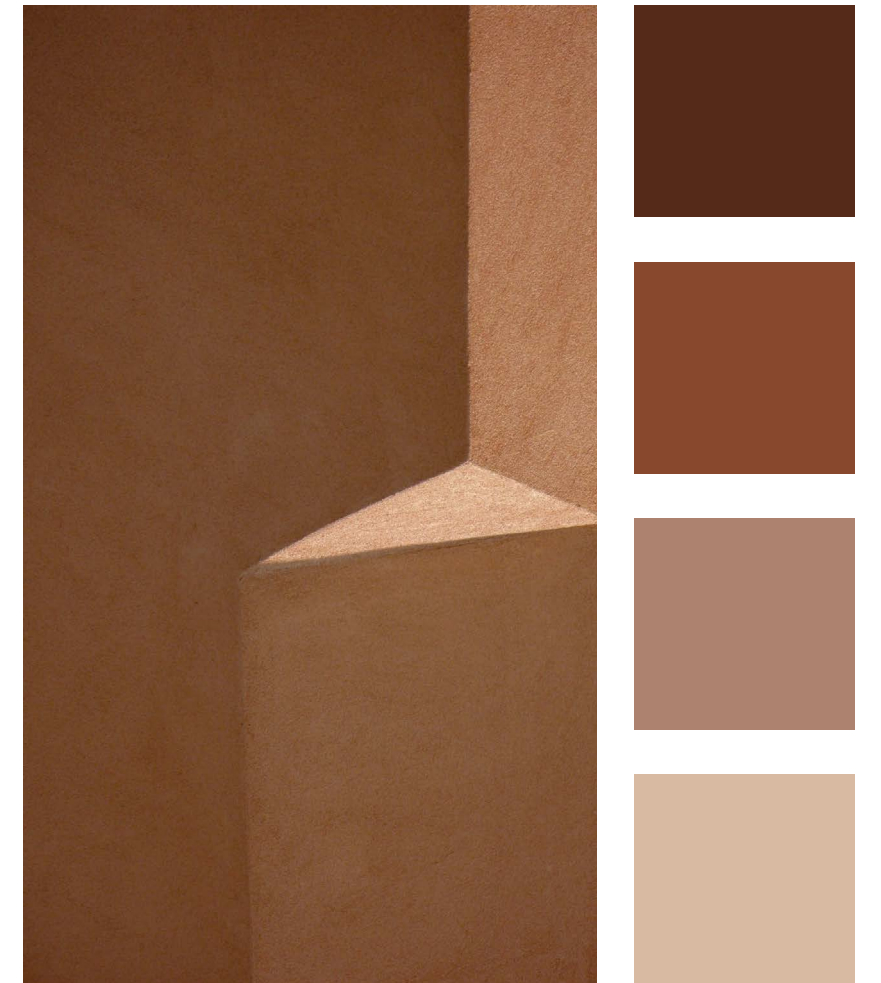

Buddie

Materiali e rivestimenti (come foto) / Materials and coverings (As shown in photos)

Cat. Shine - Art. Soft - Col. 9601
 Cuscini (pillows) Cat. Trend - Art. Tixer - Col.5
 Piedi in acciaio (Steel feet) Col. Cromato lucido

Caratteristiche del modello / Model characteristics

 Cuscini e spalliere sfoderabili
 (Seat and Back with removable covers)

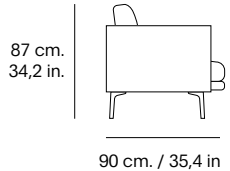

Larghezza bracciolo - Arm width 8 cm. / 3,1 in.
 Altezza seduta - Seat height 45 cm. / 17,7 in.
 Altezza bracciolo - Arm height 67 cm. / 26,3 in.
 Profondità seduta - Seat depth 54 cm. / 21,2 in.
 Altezza piedi - Feet height 20 cm. / 7,8 in.

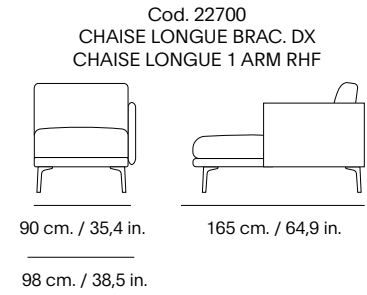
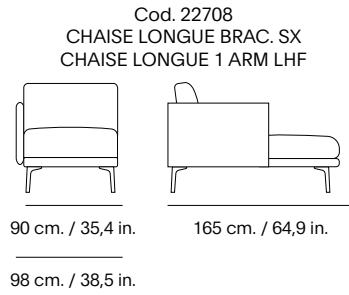
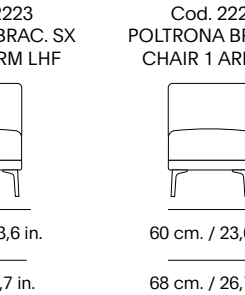
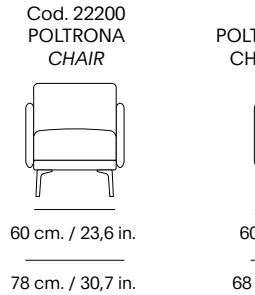
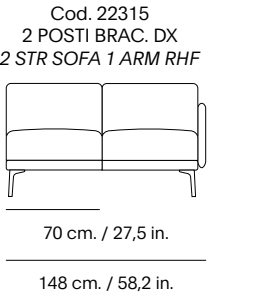
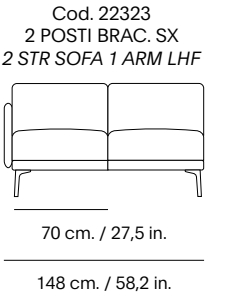
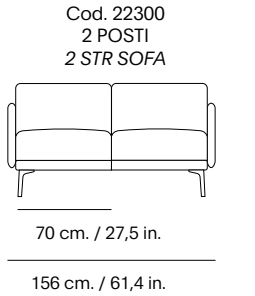
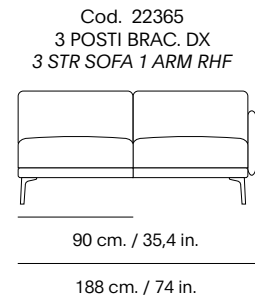
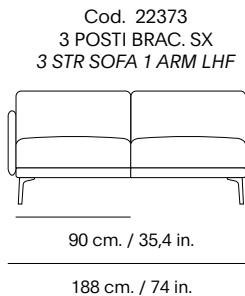
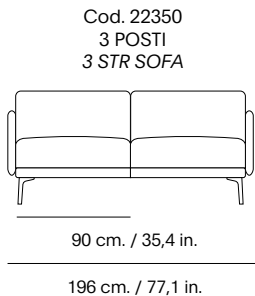

Gliss



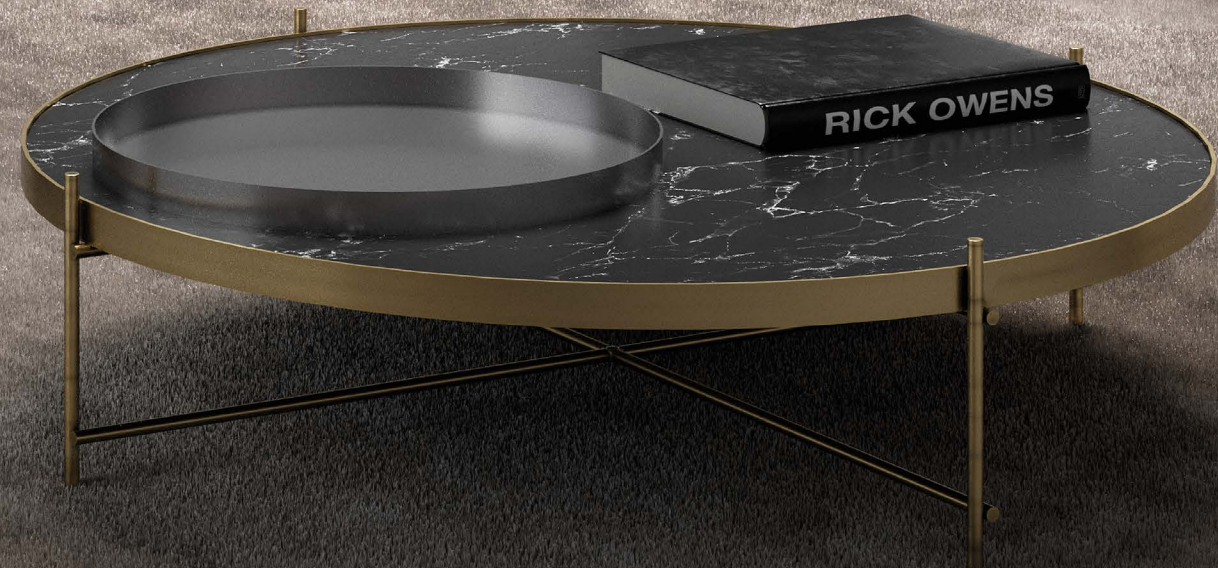

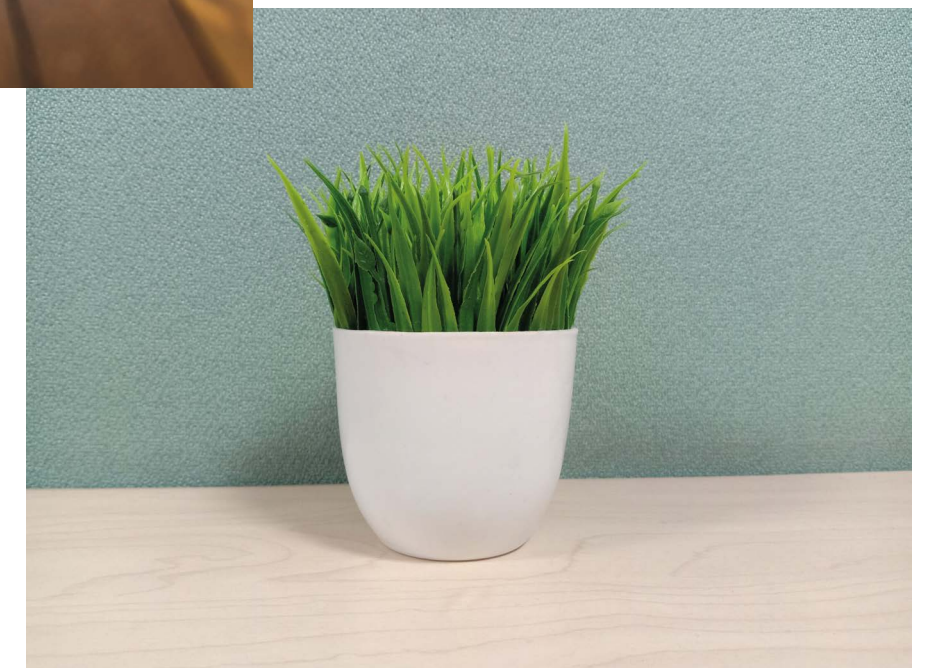

Gliss

Materiali e rivestimenti (come foto) / Materials and coverings (As shown in photos)

Cat. Trend - Art. Tixer - Col. 18
Cat. Life - Art. Amy - Col. AM753 / Col. AM11
Piedi in acciaio (Steel feet) col. Nero opaco

Caratteristiche del modello / Model characteristics

 Cuscini e spalliera sfoderabili
(Seat and back with removable covers)



Frontale bracciolo disponibile con bordino o aperto
(Front arm available with pinched piping or open)

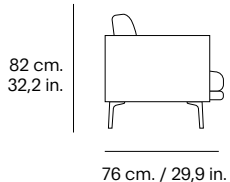

Larghezza bracciolo - *Arm width* 5 cm. / 1,9 in.
Altezza seduta - *Seat height* 46 cm. / 18,1 in.
Altezza bracciolo - *Arm height* 69 cm. / 27,1 in.
Profondità seduta - *Seat depth* 50 cm. / 19,6 in.
Altezza piedi - *Feet height* 25 cm. / 9,8 in.

Cod. 22200
POLTRONA
CHAIR

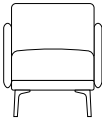

67 cm. / 26,3 in.



Taylor







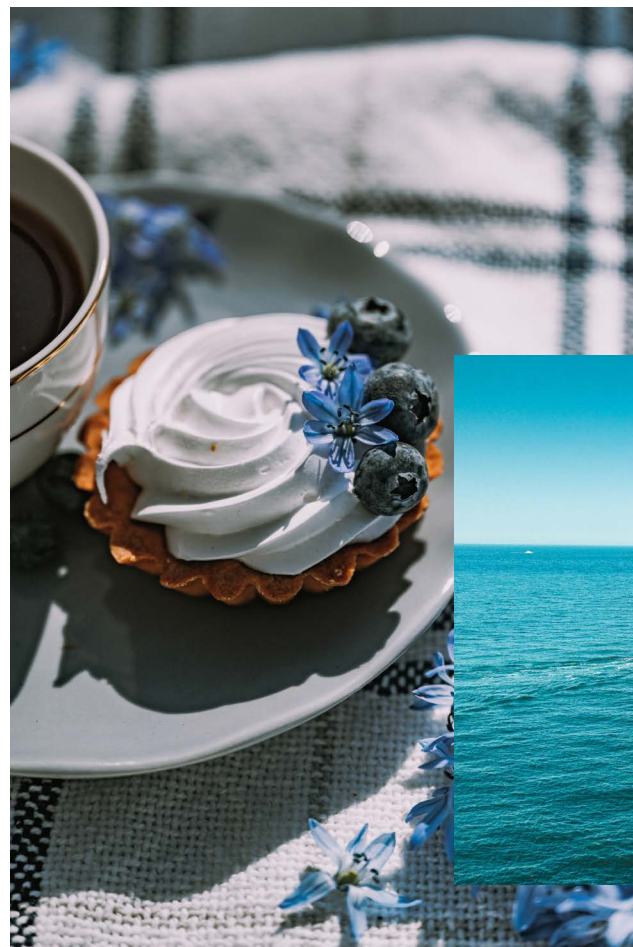

Taylor

Materiali e rivestimenti (come foto) / Materials and coverings (As shown in photos)

Cat. Basic - Art. Experience - Col. 3001
 Piedi in acciaio (Steel feet) col. Cromato lucido
 Materasso H.12 cm. (Mattress Height 12 cm. / 4,7 inches)

Caratteristiche del modello / Model characteristics

- Poggiatesta regolabile (Tilted headrest available)
- Completamente sfoderabile in tessuto (Covers completely removable in fabric)

Disponibile con materassi
 (Available with mattresses)

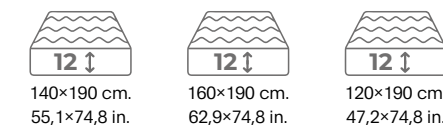

- In Pelle, solo cuscini seduta sfoderabili (In leather, seat cushions removable ONLY)

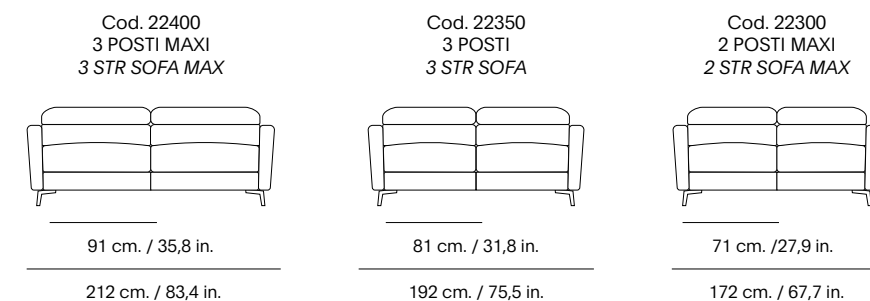
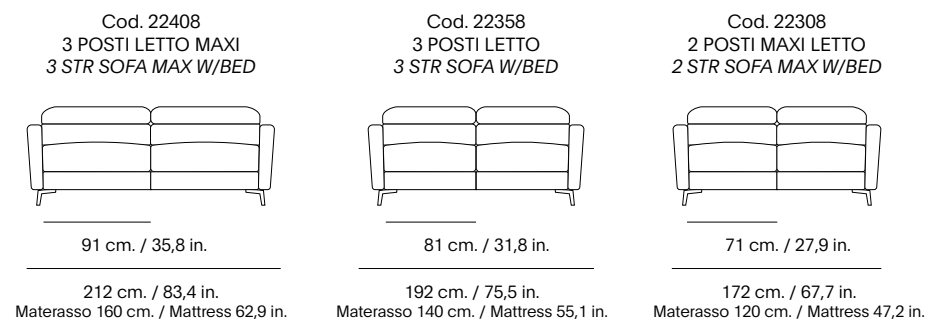
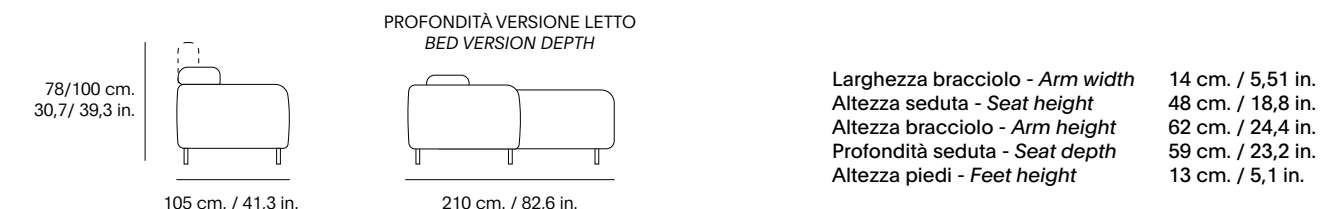

Margot







Margot

Materiali e rivestimenti (come foto) / Materials and coverings (As shown in photos)

Cat. Lux - Art. Mariclò - Col. 130
Piedi in acciaio (Steel feet) col. Nero Opaco

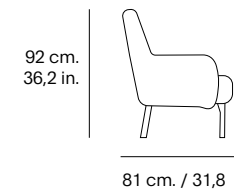

Larghezza bracciolo - *Arm width* 9 cm. / 3,5 in.
Altezza seduta - *Seat height* 43 cm. / 16,9 in.
Altezza bracciolo - *Arm height* 58 cm. / 22,8 in.
Profondità seduta - *Seat depth* 54 cm. / 21,2 in.
Altezza piedi - *Feet height* 25 cm. / 9,8 in.

Cod. 22200
POLTRONA
CHAIR



74 cm. / 29,13 in.



Yang



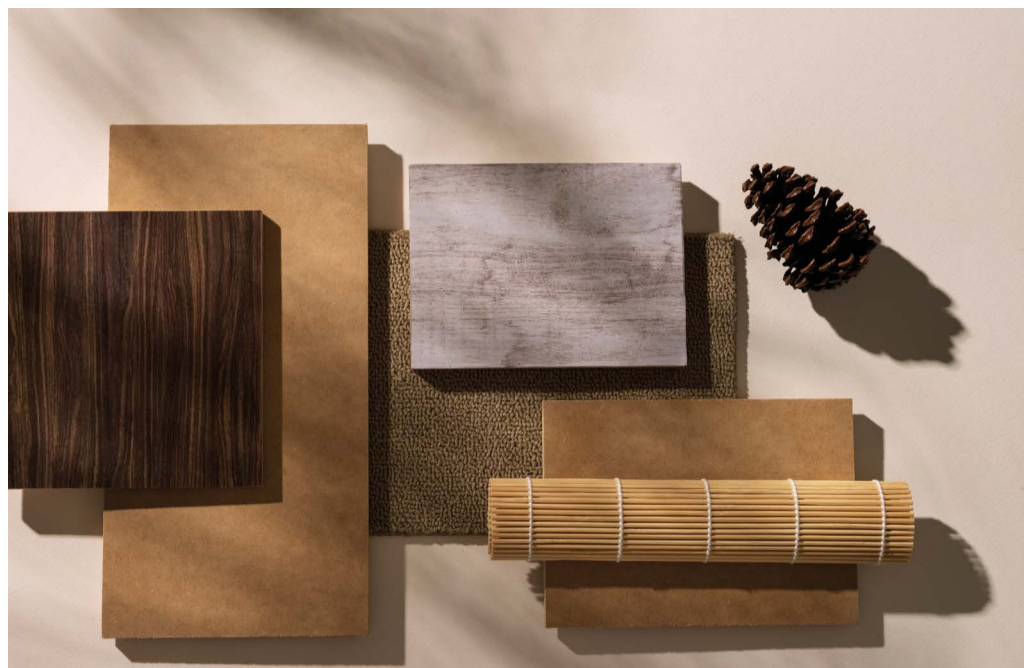



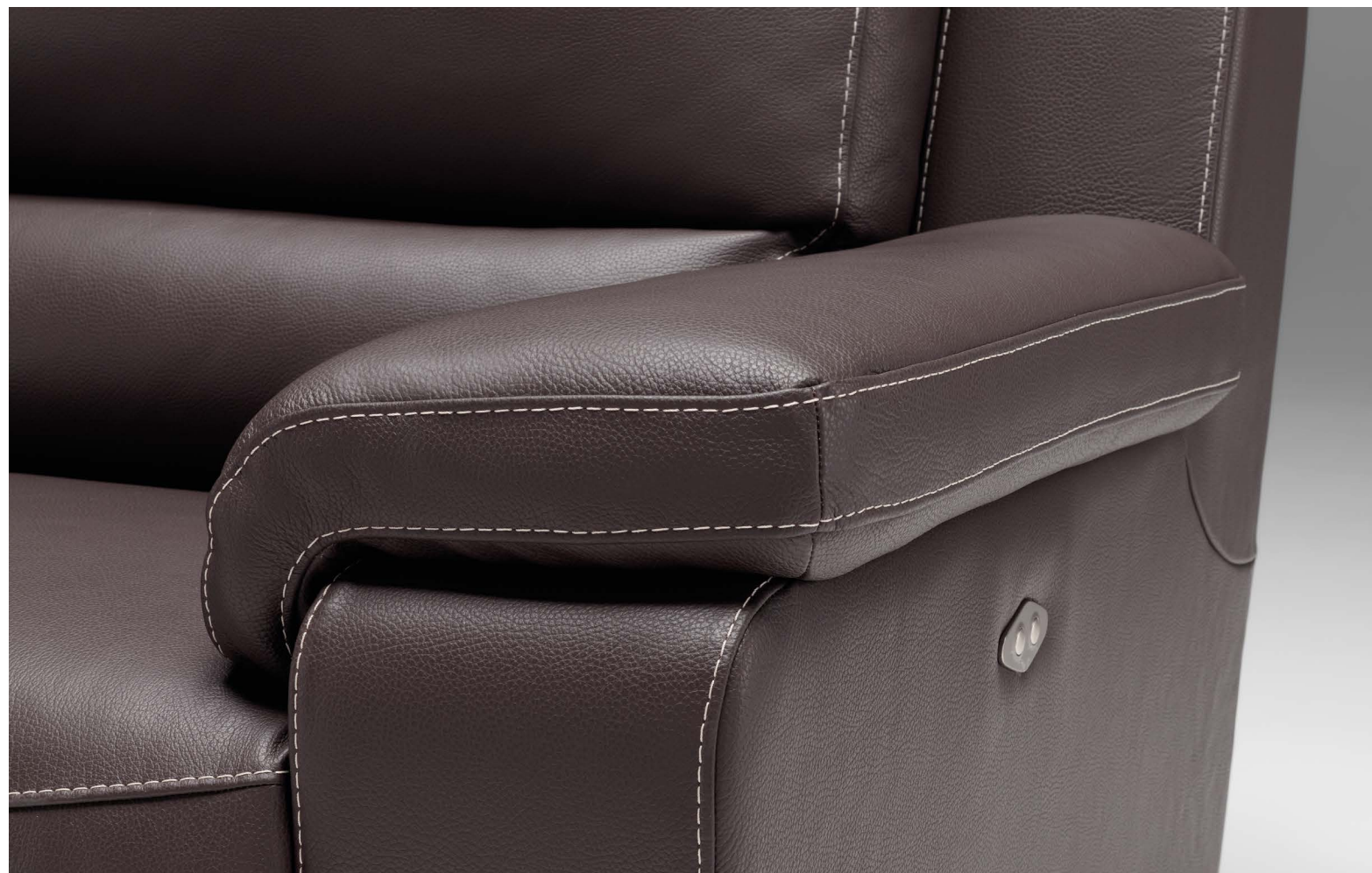

Yang

Materiali e rivestimenti (come foto) / Materials and coverings (As shown in photos)

Cat. Basic - Art. Experience - Col. 3007
 Cucitura a contrasto (Contrast Stitching) Col. Panna
 Piedi in legno (wooden feet)

Caratteristiche del modello / Model characteristics

 Poggiatesta regolabile
 (Tilted headrest available)

Optional

  Batteria e presa USB sono ordinabili su richiesta
 USB Plug-in Battery Pack Sold Separately (Upon request)

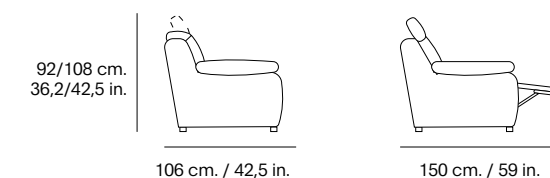

Larghezza bracciolo - Arm width 26 cm. / 10,2 in.
 Altezza seduta - Seat height 49 cm. / 19,2 in.
 Altezza bracciolo - Arm height 64 cm. / 25,1 in.
 Profondità seduta - Seat depth 56 cm. / 22 in.
 Altezza piedi - Feet height 4 cm. / 1,5 in.

Cod. 22350
 3 POSTI
 3 STR SOFA

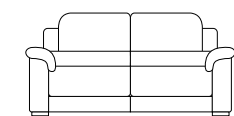

75 cm. / 29,5 in.

204 cm. / 80,3 in.

Cod. 22300
 2 POSTI MAXI
 2 STR MAX SOFA

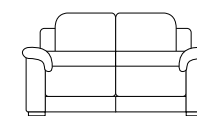

66 cm. / 25,9 in.

184 cm. / 64,5 in.

Cod. 22200
 POLTRONA
 CHAIR

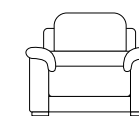

66 cm. / 25,9 in.

118 cm. / 46,4 in.

Cod. 22351RS
 3 POSTI 1 RCL SX
 3 STR 1 RECLINER LHF

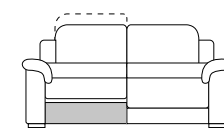

75 cm. / 29,5 in.

204 cm. / 80,3 in.

Cod. 22351RD
 3 POSTI 1 RCL DX
 3 STR 1 RECLINER RHF

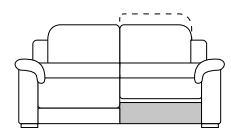

75 cm. / 29,5 in.

204 cm. / 80,3 in.

Cod. 22352R
 3 POSTI 2 RCL
 3 STR 2 RECLINERS

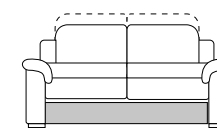

75 cm. / 29,5 in.

204 cm. / 80,3 in.

Cod. 22302R
 2 POSTI MAXI 2 RCL
 2 STR MAX 2 RECLINERS

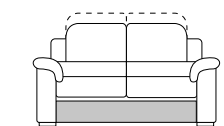

66 cm. / 25,9 in.

184 cm. / 64,5 in.

Cod. 22301RS
 2 POSTI MAXI 1 RCL SX
 2 STR MAX 1 RCL LHF

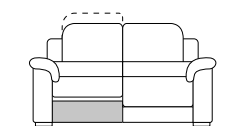

66 cm. / 25,9 in.

184 cm. / 64,5 in.

Cod. 22301RD
 2 POSTI MAXI 1 RCL DX
 2 STR MAX 1 RCL RHF

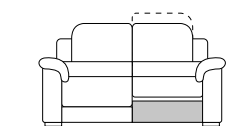

66 cm. / 25,9 in.

184 cm. / 64,5 in.

Cod. 2220R
 POLTRONA RCL
 CHAIR RECLINER

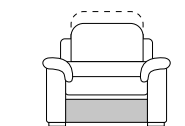

66 cm. / 25,9 in.

118 cm. / 46,4 in.



Adam



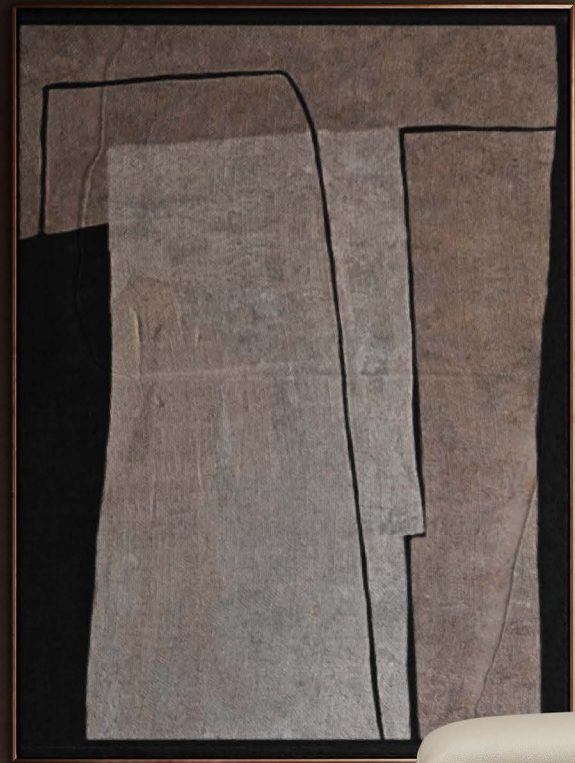
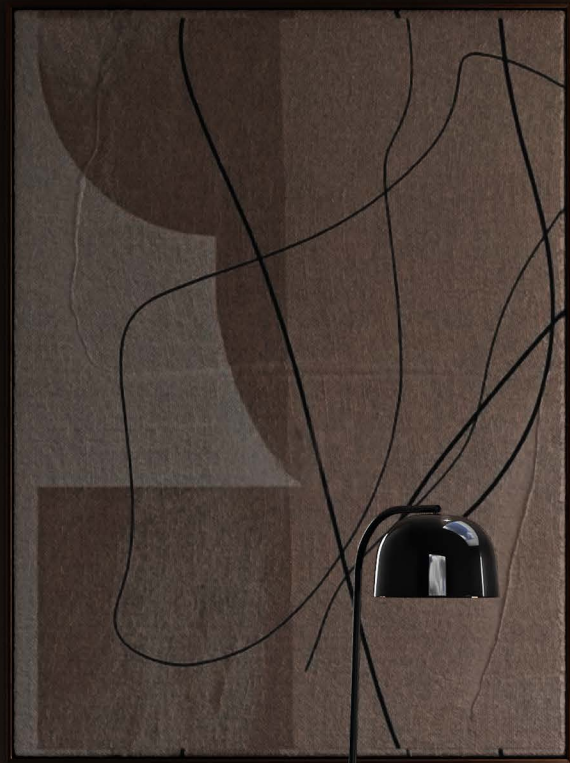





Relax completo: Con Adam, puoi goderti momenti di puro relax, mettendo i piedi in su e reclinando lo schienale per rilassare tutto il corpo.

Complete relaxation: With Adam, you can enjoy moments of pure relaxation, putting your feet up and reclining the backrest to relax all of the body.



Adam

Materiali e rivestimenti (come foto) / Materials and coverings (As shown in photos)

Cat. Basic - Art. experience - Col. 3018
Piedi in legno (Wooden feet) col. wengè

Caratteristiche del modello / Model characteristics



Poggiatesta regolabile
(Tilted headrest available)

Optional



Batteria e presa USB sono ordinabili su richiesta
USB Plug-in Battery Pack Sold Separately (Upon request)

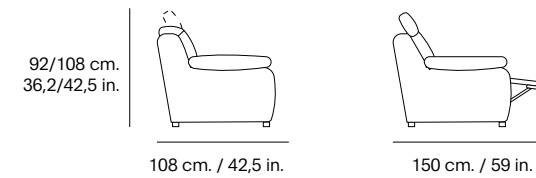

Larghezza bracciolo - Arm width 22 cm. / 8,6 in.
Altezza seduta - Seat height 46 cm. / 18,1 in.
Altezza bracciolo - Arm height 62 cm. / 24,4 in.
Profondità seduta - Seat depth 56 cm. / 22 in.
Altezza piedi - Feet height 4 cm. / 1,5 in.

<p>Cod. 22350 3 POSTI 3 STR SOFA</p> <p>75 cm. / 29,5 in. 196 cm. / 77,1 in.</p>	<p>Cod. 22300 2 POSTI MAXI 2 STR MAX SOFA</p> <p>66 cm. / 25,9 in. 176 cm. / 69,2 in.</p>	<p>Cod. 22200 POLTRONA CHAIR</p> <p>66 cm. / 25,9 in. 110 cm. / 43,3 in.</p>	
<p>Cod. 22351RS 3 POSTI 1 RCL SX 3 STR 1 RECLINER LHF</p> <p>75 cm. / 29,5 in. 196 cm. / 77,1 in.</p>	<p>Cod. 22351RD 3 POSTI 1 RCL DX 3 STR 1 RECLINER RHF</p> <p>75 cm. / 29,5 in. 196 cm. / 77,1 in.</p>	<p>Cod. 22352R 3 POSTI 2 RCL 3 STR 2 RECLINERS</p> <p>75 cm. / 29,5 in. 196 cm. / 77,1 in.</p>	
<p>Cod. 22302R 2 POSTI MAXI 2 RCL 2 STR MAX 2 RECLINERS</p> <p>66 cm. / 25,9 in. 176 cm. / 69,2 in.</p>	<p>Cod. 22301RS 2 POSTI MAXI 1 RCL SX 2 STR MAX 1 RCL LHF</p> <p>66 cm. / 25,9 in. 176 cm. / 69,2 in.</p>	<p>Cod. 22301RD 2 POSTI MAXI 1 RCL DX 2 STR MAX 1 RCL RHF</p> <p>66 cm. / 25,9 in. 176 cm. / 69,2 in.</p>	<p>Cod. 2220R POLTRONA RCL CHAIR RECLINER</p> <p>66 cm. / 25,9 in. 110 cm. / 43,3 in.</p>

Shabby









Shabby

Materiali e rivestimenti (come foto) / Materials and coverings (As shown in photos)

Cat. Trend - Art. Casinò - Col. Brick
 Piedi in acciaio (Steel feet) col. Nero Opaco
 Materasso (Mattress) Height 16 cm / 6,2 in.

Disponibile con materassi
 (Available with mattresses)

Caratteristiche del modello / Model characteristics



Completamento sfoderabile
 (Completely removable covers)



In Pelle, solo cuscini seduta sfoderabili
 (In leather, seat cushions removable ONLY)



140×190 cm.
 55,1×74,8 in.



160×190 cm.
 62,9×74,8 in.



120×190 cm.
 47,2×74,8 in.

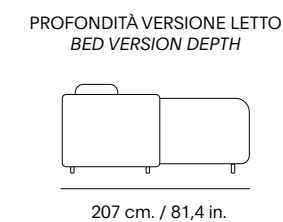
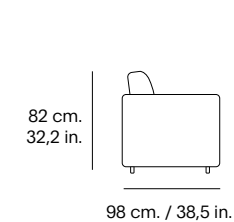

Larghezza bracciolo - Arm width 10 cm. / 3,9 in.
 Altezza seduta - Seat height 45 cm. / 17,7 in.
 Altezza bracciolo - Arm height 59 cm. / 23,2 in.
 Profondità seduta - Seat depth 57 cm. / 22,4 in.
 Altezza piedi - Feet height 8 cm. / 3,1 in.

Cod. 22408
 3 POSTI LETTO MAXI
 3 STR SOFA MAX W/BED

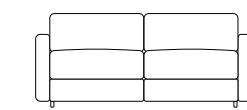

91 cm. / 35,8 in.
 205 cm. / 80,7 in.
 Materasso 160 cm. / Mattress 62,9

Cod. 22358
 3 POSTI LETTO
 3 STR SOFA W/BED

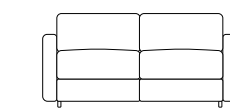

81 cm. / 31,8 in.
 195 cm. / 76,7 in.
 Materasso 140 cm. / Mattress 55,1

Cod. 22308
 2 POSTI MAXI LETTO
 2 STR SOFA MAX W/BED

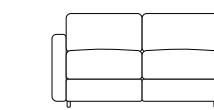

71 cm. / 27,9 in.
 175 cm. / 68,8 in.
 Materasso 120 cm. / Mattress 47,2

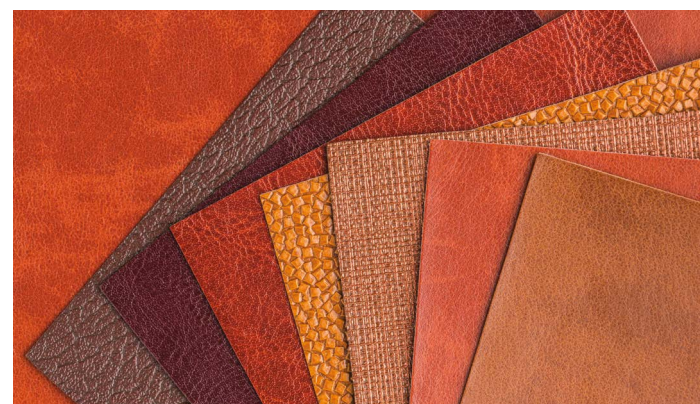

Walter









Walter

Materiali e rivestimenti (come foto) / Materials and coverings (As shown in photos)

Cat. Air - Art. Galaxy - Col. 7317
 Materasso H 16 cm. / 6,2 in. (Mattress Height 16 cm. / 6,2 in.)
 Piedi in legno (Wooden feet) col. Noce chiaro

Disponibile con materassi
 (Available with mattresses)

Caratteristiche del modello / Model characteristics

 Poggiatesta regolabile
 (Tilted headrest available)

 Cuscini seduta sfoderabili nella versione letto
 (Seat ONLY completely removable covers)
 Versione fissa non sono sfoderabili
 (Fixed version NON removable covers)

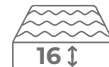
 16 ↑
 140×190 cm.
 55,1×74,8 in.

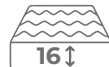
 16 ↑
 160×190 cm.
 62,9×74,8 in.

 16 ↑
 120×190 cm.
 47,2×74,8 in.

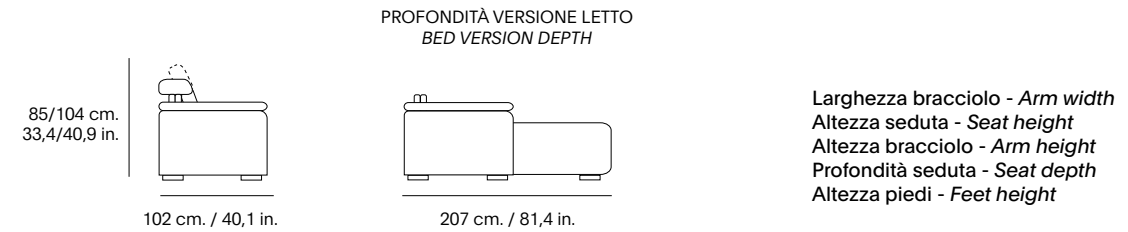

Cod. 22408
 3 POSTI LETTO MAXI
 3 STR SOFA MAX W/BED

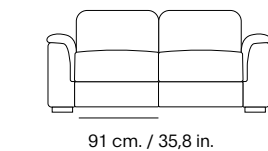

230 cm. / 90,5 in.
 Materasso 160 cm. / Mattress 62,9 in.

Cod. 22358
 3 POSTI LETTO
 3 STR SOFA W/BED

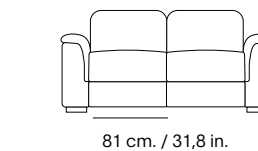

210 cm. / 82,6 in.
 Materasso 140 cm. / Mattress 55,1 in.

Cod. 22308
 2 POSTI LETTO MAXI
 2 STR SOFA MAX W/BED

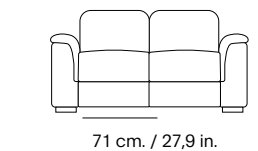

190 cm. / 74,8 in.
 Materasso 120 cm. / Mattress 47,2 in.

Cod. 22400
 3 POSTI MAXI
 3 STR SOFA MAX

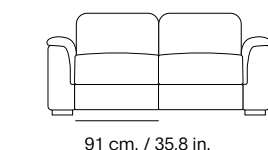

230 cm. / 90,5 in.

Cod. 22350
 3 POSTI
 3 STR SOFA

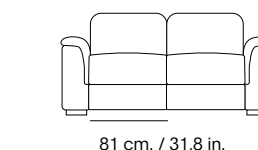

210 cm. / 82,6 in.

Cod. 22300
 2 POSTI MAXI
 2 STR SOFA

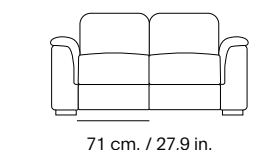

190 cm. / 74,8 in.



Ideazione e realizzazione / Conception and realization

Simboli Italia - R&D LAB

Photo

STUDIO SET- Ruvo di Puglia (BA)

Finito di stampare / Printed

Settembre 2023 / September 2023

Antezza Tipografi - Matera

Copyright©

Simboli Italia 2023

tutti i diritti riservati / *all rights reserved*

Simboli Italia si riserva la facoltà di modificare, in qualunque momento e senza preavviso, le caratteristiche tecniche dei modelli illustrati nel presente catalogo. I colori sono da considerarsi puramente indicativi.

Simboli Italia reserves the right to change, at any time and without notice, the technical characteristics of the models illustrated in this catalog. Colors are to be considered purely indicative.

Simboli

Italia

Sede legale:

Viale Da Vinci L.,128
80055 - Portici (NA) ITALY
Tel. +39 0828 380 383

Sede operativa:

Via Luca Giordano, 32
84092 - Bellizzi (SA) ITALY
Tel. +39 0828 380 383
info@simbolitalia.com

Per ulteriori informazioni visitate il nostro sito web.
For further information please visit our website

simbolitalia.com